



Spec Guide

BoxRail | Ceiling Cable | 107



Direct or indirect lighting for open office and ambient applications.



BoxRail: direct or indirect, infinite rotation

Benefits & Features

Minimal Profile, Robust Design

Double Rail performance in a small square profile, 1.14 in x 1.14 in.

Superior Light Quality & Performance

Output up to 1521 lm/ft (HO), 125 lm/W (HO). 90 CRI static & tunable white 2200K - 5000K. Custom ranges available upon request.

High Performance Optics

Break through Batwing lens designed for excellent fixture to fixture spacing.

Continuous Line of Light

Continuous line of light between rail sections.

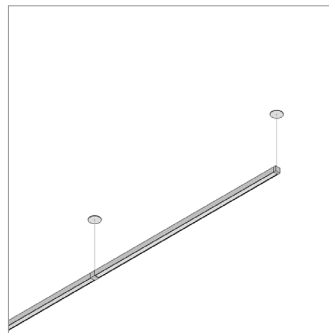

Large Round Canopy,
Remote Power

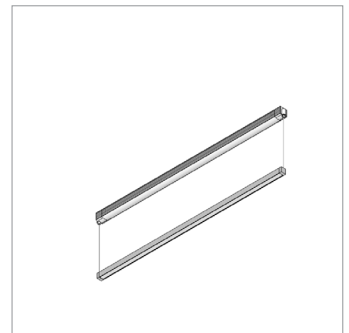

Integral Power

Build Your Specification

107-BX	01			CC	»
--------	----	--	--	----	---

System & Rail Type	Single/Double Rail	System Length	Rail Length	Mounting	Cable Length
107-BX BoxRail	01 Single Rail	Specify overall system length in ft/in or M/mm. <i>Corner and Shapes Available</i> See Guide for details.	24 24" (610mm) 36 36" (914mm) 48 48" (1219mm) 60 60" (1524mm) 72 72" (1829mm) ZZ Other rail length or layout (please specify) See Rail Length Chart for more details. ▲ Custom lengths may result in light gaps on the fixture. See Rail Length Chart for more details.	CC Ceiling Cable	<i>Field adjustable.</i> 48 48" cable (1219mm) 96 96" cable (2438mm) ZZ Other (please specify)

					»
--	--	--	--	--	---

Power Location	Power Type	Voltage	Emergency Power
Integral Power IP Integral Power Remote Power Specify mounting and harness length code example: 2R25, 4R25 ...etc. Mounting Option	Flexible 1 to 1 Power AE 0-10v, 1.0% Dimming AT 0-10v, 0.1% Dimming AD DALI, 0.1% Dimming AX DMX, 100-0% Dimming AH Hi-lume 1% EcoSystem, Soft On / Fade to Black Technology, LDE ¹ AH2 ELV 1% 2-wire (Forward and Reverse Phase) Optimized Power Add 'O' to power type example: AEO, ATO...etc. ¹ VodeNODE Add 'N' to power type for Flexible 1 to 1 Power Add 'ON' to power type for Optimized Power example: AEN, ATN, AEON, ADON...etc. ² ZZ Other (please specify) See Power Guide for driver features & limitations.	1 120V 2 120V - 277V X Not Yet Specified	0 No Emergency Power ZZ Emergency Power (specify requirements)
Wire Harness 2R Small Round Canopy 10 10' (3.048m) Wire Harness 4R Large Round Canopy 25 25' (7.62m) Wire Harness 50 50' (15.24m) Wire Harness 75 75' (22.86m) Wire Harness 100 100' (30.48m) Wire Harness			

» Z				
-----	--	--	--	--

LED Type	Lumen Output	Color Temperature	Optics	Sensors ⁶
Z Zipper Board	LO Low Output SO Standard Output HO High Output ZZ Other (please specify) See IES Files page for details. See Power Guide for driver features & limitations.	90+ CRI 27 2700K 30 3000K 35 3500K 40 4000K ZZ Tunable White Available See Guide for details.	Zipper Board (Z) 1 Diffuse WB White Baffle BB Black Baffle G1 120° Batwing G2 120° FlyWing S1 40° Symmetric S2 60° Symmetric A1 85° Asymmetric	0 None ENC Canopy with integrated Enlighted Micro Sensor ⁵ WSC Canopy with integrated Legrand Wattstopper sensor ⁵ LAC Canopy with integrated Lutron Athena sensor ⁵ ZZ Other (please specify)

NOTES & LIMITATIONS

- ¹ Optimized Power is not available with Hi-lume 1% EcoSystem (AHO) Power Type.
- ² VodeNODE enclosure is not available with ELV 1% 2-wire (AH2) Power Type.
- ³ 9' 18/3 Cord and Plug only available with Remote Power (RP).
- ⁴ Chicago Plenum not applicable for wall arm mounting.
- ⁵ Rotating fixture as an uplight will interfere with sensor operation.
- ⁶ Sensors, drivers, and control units that are integrated into Vode fixtures are discrete components that communicate with network lighting controls. For more information about each network lighting control system, visit the manufacturer's website for additional system information and technical data sheets.
For general information about network lighting controls, consult the DesignLights Consortium® (DLC) [Networked Lighting Control Qualified Product List](#)

»	
---	--

Finish	Options
AL Clear Anodized WH White Powder Coat BL Black Anodized ZZ Other (please specify)	0 None 9 9' 18/3 Cord and Plug CPP Chicago Plenum Power LLLC Luminaire Level Lighting Controls

Standard 5 Year Limited Warranty. See details [here](#). Contact factory for options on Limited Warranties up to 20 years.

Listed to UL standards for damp location by a Nationally Recognized Testing Laboratory (NRTL) recognized by OSHA. Certain limitations exist for each Certification. Contact factory for verification.



Applications

General Interior, Open Office

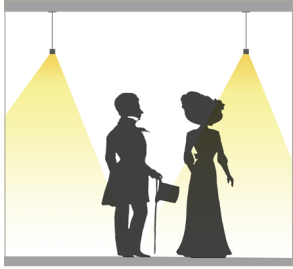

Microsoft's Mid-Market Offices, San Francisco, CA

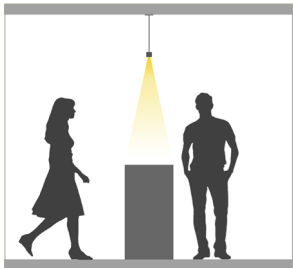

Rapt Studio, San Francisco, CA

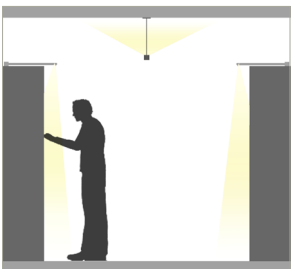

Libbie Mill Library, Richmond, VA

Applications

General Interior, Open Office



Sheppard Mullin, San Francisco, CA

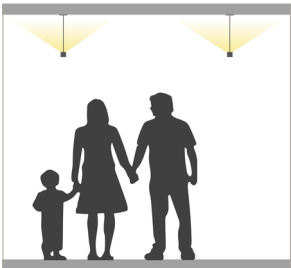

Harold C. Smith Learning Commons, Springfield, MA

Sustainability & Certifications

DECLARE

International Living Future Institute (ILFI)



All Vode Lighting linear light fixtures proudly carry the Red List Approved designation.

Declare.SM

Vode Adaptive Architectural Lighting Systems
Vode Lighting LLC

Final Assembly: Sonoma, California, US
Life Expectancy: 10+ Year(s)
End of Life Options: Recyclable (100%)

Ingredients:

Steel; Anodized Aluminum (6063-T5 Alloy); Small Electrical Component (RoHS); Copper; **Fluorinated Ethylene Propylene (masterbatch)**; Polymethyl methacrylate (PMMA); Stainless Steel; Polyoxymethylene Copolymer (POM); Styrene-butadiene polymer, hydrogenated; Poly(methyl methacrylate/butyl acrylate/styrene) (PMMA/BA/S); Styrene/butadiene copolymer; Distillates; Polypropylene; Calcium carbonate; Polycarbonate; EVA Copolymer; Methyl methacrylate (MMA); Polyphenylene Oxide; Brass; Tin, Organic

Living Building Challenge Criteria: Compliant

I-13 Red List:

LBC Red List Free % Disclosed: 100% at 100ppm
 LBC Red List Approved VOC Content: Not Applicable
 Declared

I-10 Interior Performance: Not Applicable
I-14 Responsible Sourcing: Not Applicable

VDE-0001
 EXP. 01 FEB 2026
 Original Issue Date: 2018

MANUFACTURER RESPONSIBLE FOR LABEL ACCURACY
 INTERNATIONAL LIVING FUTURE INSTITUTE™ living-future.org/declare

Click here to learn more: International Living Future Institute

TM65NA

CIBSE & ASHRAE on Embodied Carbon

Vode recognizes TM65NA as the highest standard for understanding the embodied carbon of our fixtures.

Developed with ASHRAE, it adapts CIBSE's TM65 for North America, ensuring accurate regional assessments. It must be used alongside TM65 and follows TM65LA's framework.

System: 107 | BoxRail | CC
Embodied Carbon (kg CO₂e): 48.72*

***Note:** Embodied Carbon, expressed in kilograms of CO₂e is calculated using a 48" fixture **and includes the LED driver.**



Click here to learn more [CIBSE, ASHRAE](#).

BAA X BABA

Buy American Act / Build America & Buy America Act Compliance

Vode is dedicated to supporting domestic manufacturing and ensuring compliance with BAA and BABA requirements.

Given the complexity of our products, we recommend reaching out to vodecares@vode.com for confirmation regarding compliance for your specific project.



Click here to learn more: US Department of Commerce

Structure

Rail Lengths	24" (610mm) - 72" (1829mm). Modified lengths available. See Rail Length Chart for more details.
Rail Dimensions	1.14" (29mm) x 1.14" (29mm) x length.
Construction	Extruded and machined 6063 aluminum.
Mounting	Ceiling mount to jbox or driver housing.
Cable Length	48" (1220mm) and 96" (2438mm) available. Field adjustable. Non-standard cable lengths available.
System Run Length	24" (610mm) minimum. Unlimited maximum.
Operating Temperature	32°F to 104°F (0°C to 40°C).
Humidity	0-85%, non-condensing.
System Weight	0.99 lbs per ft (0.45kg per 305mm) Power supply and housing not included.

Materials

LED Board Construction	Aluminum core PCB, black LCP connectors, RoHS compliant.
Lens	High-impact extruded acrylic glass (PMMA).
Baffle	6063 aluminum, RoHS compliant painted finish.
Suspension Cable	Ø3.3mm, 22/2 AWG, PVC or TPE and RoHS compliant, Red List Approved.
Power Cable	Ø4mm, 18/2 AWG, Plenum (CMP) rated semi-rigid PVC or FEP, flame tested UL-910, Red List Approved.
Cable Connectors	Unfilled black nylon, rated UL 94 V-0, halogen free, PVC or FEP overmold, RoHS compliant, Red List Approved.
Remote Linear Power Housing (RLP)	20.7" x 2.375" x 2.53", 0.054" formed Galvanized Steel.
Remote Brick Power Housing (RBP)	4.32" x 3.37" x .078" Galvanized Steel mounting plate.

Dimensions

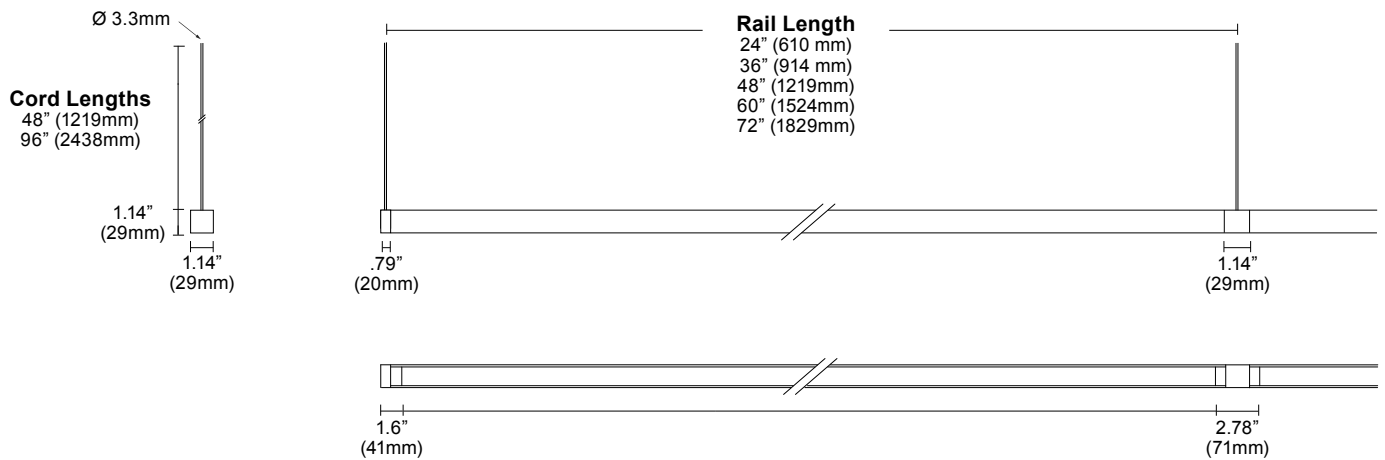

Mounting Options

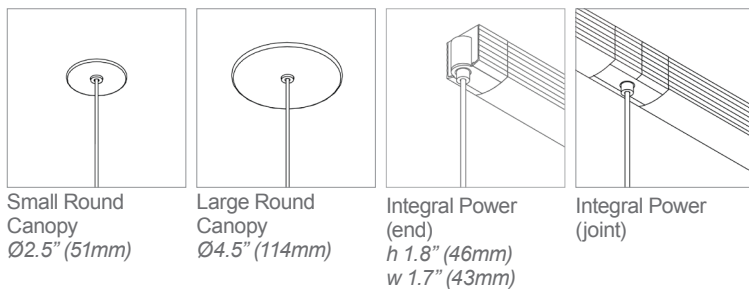

Layout

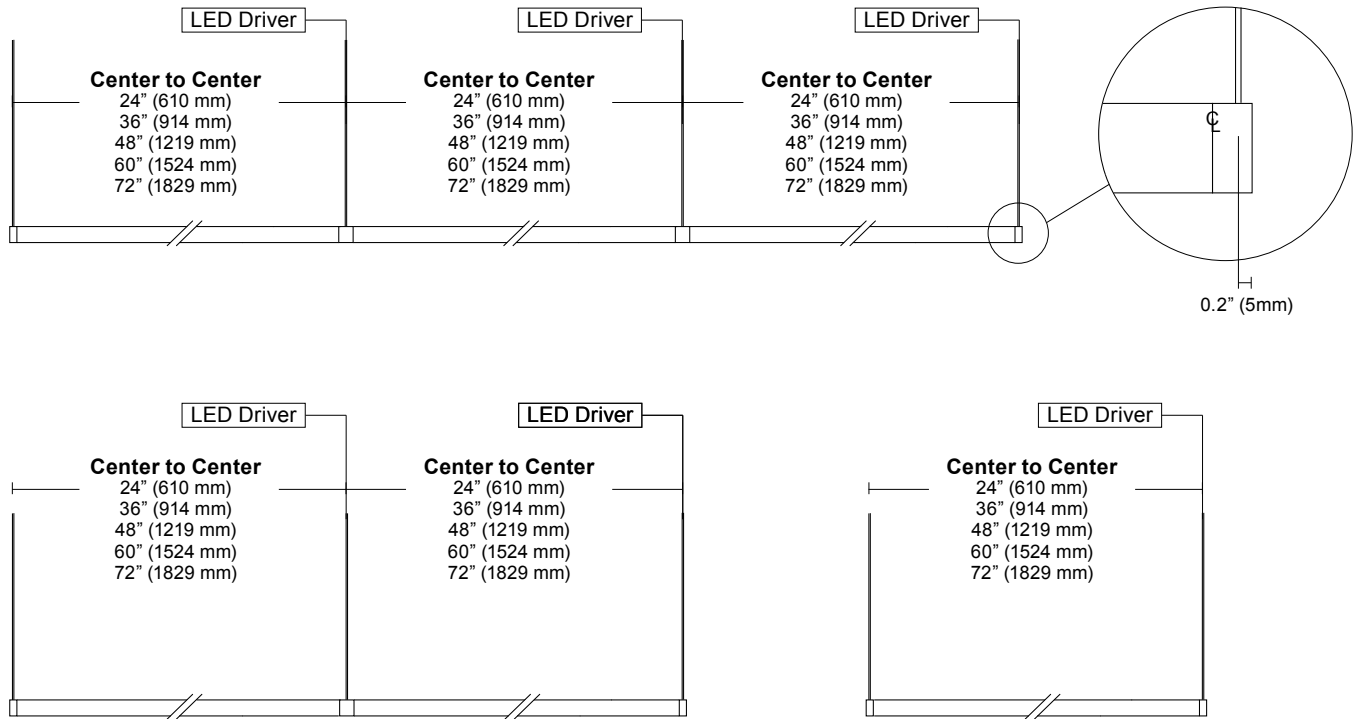

Corner and Shapes Available (Square, Rectangle, L-Shape, U-Shape, ZigZag) [See Guide](#) for details.

Power and Controls

Power Type	Class 2 (<60V output) constant current driver.
Dimming Controls	Dimming (0.1%, 1%), 0-10V, DALI, DMX, Hi-lume 1% are available. See Power Guide for details.
Input Voltage	120V - 277V, 50/60hz.
Power Location	Integral or remote power. Maximum remote distance up to 100' (30.5m) depending on driver selection. See Power Guide for details.

Vode power locations fall into two categories: integral and remote. Remote power is locating the power supply away from the fixture. Remote power comes in two housing styles: brick style and linear style. Consult [Power Guide](#) to determine which type you will receive. Integral power is locating the power supply into the lighting fixture or mounting.

Remote Brick Power Housing

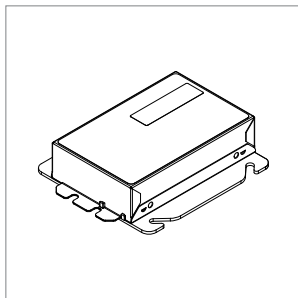

Supplied for some remote power applications. One remote power supply housing is supplied for each rail. Provided driver mounting plate fits standard 4" metal, square J-Boxes with a minimum volume of 21 in³ (J-Box not provided). See [Tech Sheet](#) for details.

Remote Linear Power Housing

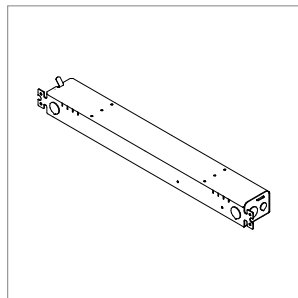

One remote power supply housing is supplied with each power supply. All Vode linear remote drivers come in a 0.054" (0.8mm) formed galvanized steel power supply housing with five (5) knockouts: (4) 1-1/8", (1) 7/8" and (1) 9/16". Accommodates standard linear power supplies. See [Tech Sheet](#) for details.

Integral Power

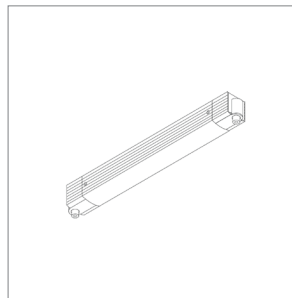

Houses integral power supply. Direct conduit feed is recommended, but integral power supply housing will mount to any standard North America 4" j-box. Mounts to most surfaces. Blocking is recommended at all arm junctions. See [Tech Sheet](#) for details.

Wire Harness

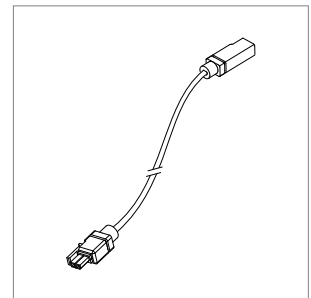

Wire harness connects driver to rail section. Lengths of 10' (3.0m) & 25' (7.6m) with snap-lock connectors for quick and easy installation. Multiple harnesses may be combined for lengths up to 100' (30.5m). See [Tech Sheet](#) for details.

vodeCONNECT Sensors

Canopy with integrated sensor

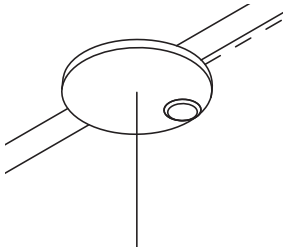

Sensor partners



Integrated canopy sensor layout ¹

1 sensor per fixture. See [vodeCONNECT brochure](#) for more details.

NOTES: 1. Available with Large Round Canopy only.

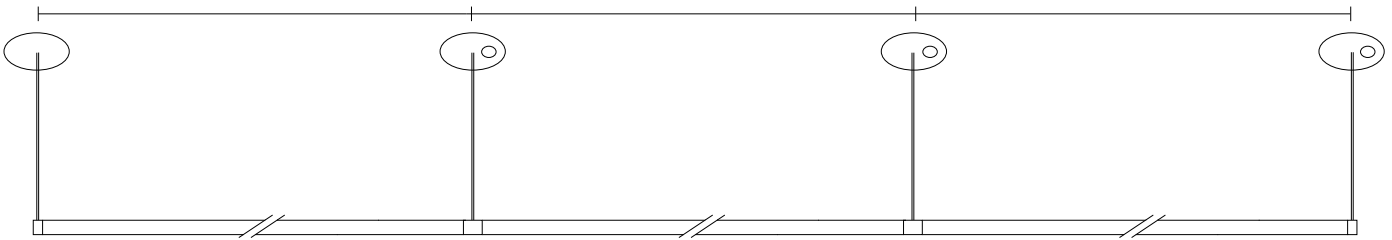

Compatible sensors



Lutron Athena



Legrand Wattstopper



Enlighted Micro Sensor

Power and Controls

Flexible 1 to 1 power

For Flexible 1 to 1 Power, Vode supplies one single output driver per fixture, allowing each fixture to be controlled independently. Direct/Indirect fixtures are supplied with two single output drivers, allowing the direct and indirect lighting to be controlled independently. Consult [Power Guide](#) to determine which type you will receive.

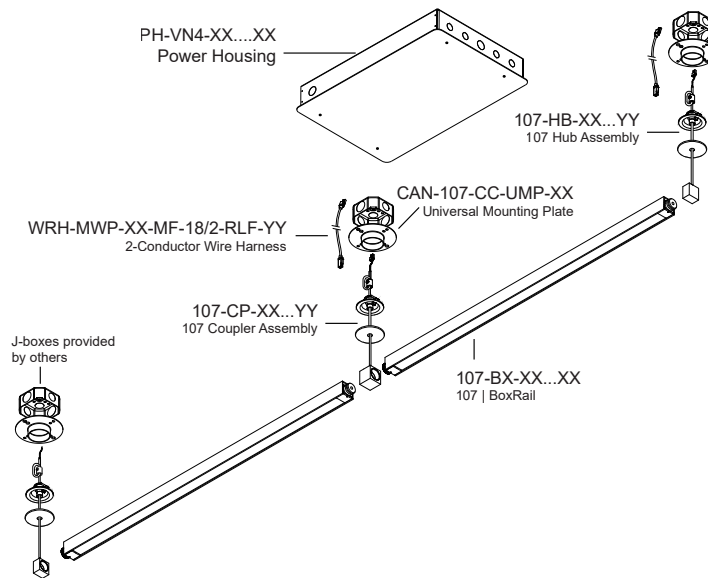

Optimized Power

To optimize power, Vode configures specifications with drivers that have 2 or 4 outputs. Depending on system configurations and power requirements, up to 4 fixtures can be powered from a 4-output driver. Consult [Power Guide](#) to determine which type you will receive.

IMPORTANT: Each fixture will still require individual wire harnesses, as shown below.

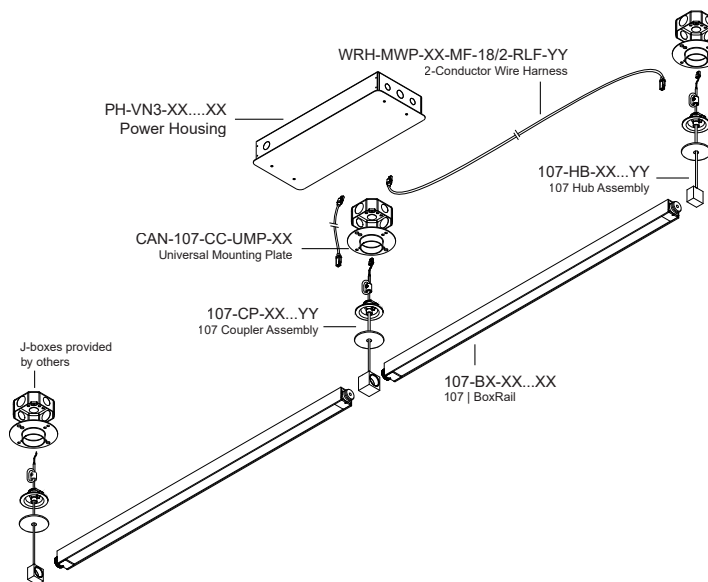

Note: Drawings not to scale, for reference only.

Finish

Clear Anodized Finish

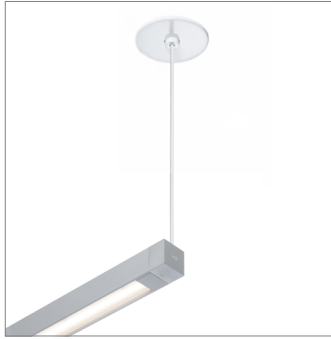

Clear Anodized Rail, White Canopy/Clear Anodized Integral Power, White Cable

White Powder Coat Finish



White Rail, White Canopy/Integral Power, White Cable

Black Anodized Finish



Black Rail, Black Canopy/Integral Power, Black Cable

Performance | Zipper Board Optics

Zipper Board Optics design has 72 diodes per foot (305mm).

Diffuse (1)

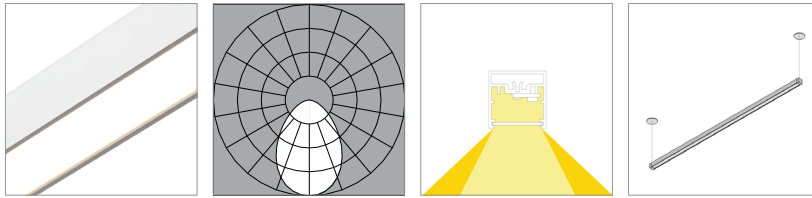

L90 >100,000 hours

90 CRI (90min., 96 avg.)

	2700K	3000K	3500K	4000K
Low Output (LO)				
Efficacy - Lumens per Watt	81	83	85	86
Lumens per foot (305mm)	277	286	292	294
Watts per foot (305mm)	3.5	3.5	3.5	3.5
Standard Output (SO)				
Efficacy - Lumens per Watt	93	96	98	99
Lumens per foot (305mm)	554	571	583	589
Watts per foot (305mm)	6.0	6.0	6.0	6.0
High Output (HO)				
Efficacy - Lumens per Watt	86	89	91	92
Lumens per foot (305mm)	1052	1086	1108	1119
Watts per foot (305mm)	12.3	12.3	12.3	12.3

Performance | Zipper Board Optics

Zipper Board Optics design has 72 diodes per foot (305mm).

White Baffle (WB)

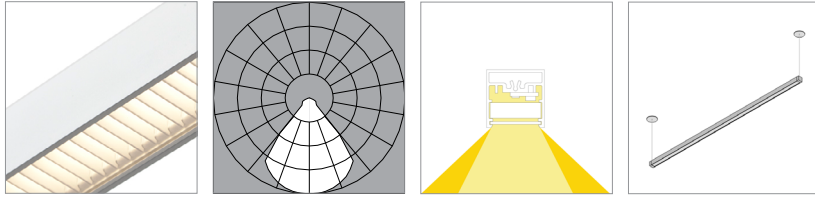

L90 >100,000 hours

90 CRI (90min., 96 avg.)

Low Output (LO)	2700K	3000K	3500K	4000K
Efficacy - Lumens per Watt	56	58	59	60
Lumens per foot (305mm)	192	199	203	205
Watts per foot (305mm)	3.5	3.5	3.5	3.5

Standard Output (SO)	2700K	3000K	3500K	4000K
Efficacy - Lumens per Watt	65	67	68	69
Lumens per foot (305mm)	385	397	405	409
Watts per foot (305mm)	6.0	6.0	6.0	6.0

High Output (HO)	2700K	3000K	3500K	4000K
Efficacy - Lumens per Watt	60	62	63	64
Lumens per foot (305mm)	731	755	770	778
Watts per foot (305mm)	12.3	12.3	12.3	12.3

Black Baffle (BB)

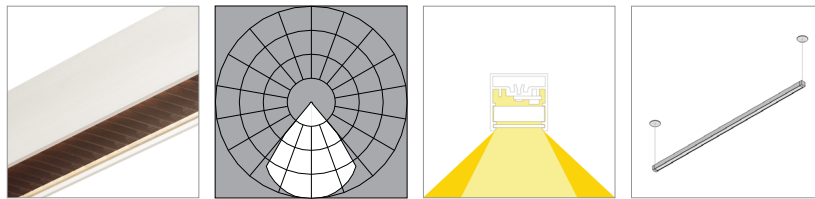

L90 >100,000 hours

90 CRI (90min., 96 avg.)

Low Output (LO)	2700K	3000K	3500K	4000K
Efficacy - Lumens per Watt	31	31	32	32
Lumens per foot (305mm)	104	107	109	110
Watts per foot (305mm)	3.5	3.5	3.5	3.5

Standard Output (SO)	2700K	3000K	3500K	4000K
Efficacy - Lumens per Watt	35	36	37	37
Lumens per foot (305mm)	207	214	218	220
Watts per foot (305mm)	6.0	6.0	6.0	6.0

High Output (HO)	2700K	3000K	3500K	4000K
Efficacy - Lumens per Watt	33	34	34	35
Lumens per foot (305mm)	394	406	415	419
Watts per foot (305mm)	12.3	12.3	12.3	12.3

Performance | Zipper Board Optics

Zipper Board Optics design has 72 diodes per foot (305mm).

120° Batwing (G1)

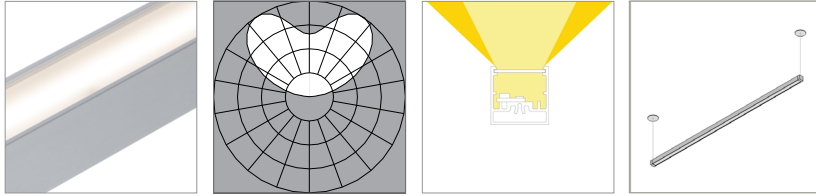

L90 >100,000 hours

90 CRI (90min., 96 avg.)

Low Output (LO)	2700K	3000K	3500K	4000K
Efficacy - Lumens per Watt	94	97	99	100
Lumens per foot (305mm)	323	333	340	344
Watts per foot (305mm)	3.5	3.5	3.5	3.5

Standard Output (SO)	2700K	3000K	3500K	4000K
Efficacy - Lumens per Watt	108	111	113	114
Lumens per foot (305mm)	640	661	674	681
Watts per foot (305mm)	6.0	6.0	6.0	6.0

High Output (HO)	2700K	3000K	3500K	4000K
Efficacy - Lumens per Watt	100	104	106	107
Lumens per foot (305mm)	1226	1265	1291	1303
Watts per foot (305mm)	12.3	12.3	12.3	12.3

120° FlyWing (G2)

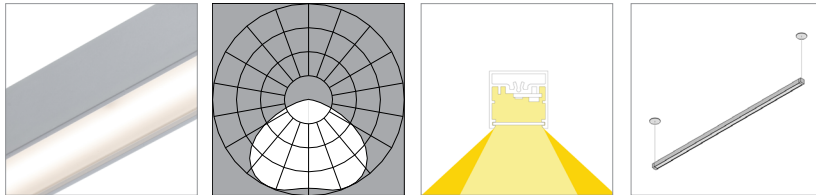

L90 >100,000 hours

90 CRI (90min., 96 avg.)

Low Output (LO)	2700K	3000K	3500K	4000K
Efficacy - Lumens per Watt	95	98	100	101
Lumens per foot (305mm)	328	338	345	349
Watts per foot (305mm)	3.5	3.5	3.5	3.5

Standard Output (SO)	2700K	3000K	3500K	4000K
Efficacy - Lumens per Watt	110	114	116	117
Lumens per foot (305mm)	656	676	690	697
Watts per foot (305mm)	6.0	6.0	6.0	6.0

High Output (HO)	2700K	3000K	3500K	4000K
Efficacy - Lumens per Watt	102	105	107	108
Lumens per foot (305mm)	1246	1285	1311	1325
Watts per foot (305mm)	12.3	12.3	12.3	12.3

Performance | Zipper Board Optics

Zipper Board Optics design has 72 diodes per foot (305mm).

40° Symmetric (S1)

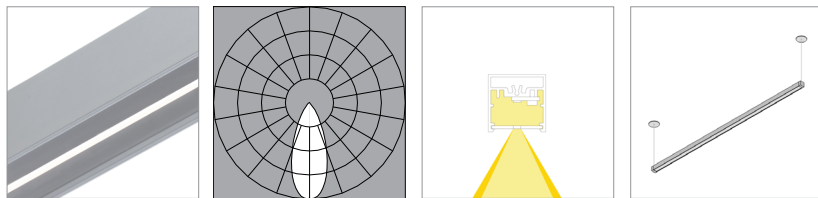

L90 >100,000 hours

90 CRI (90min., 96 avg.)

Low Output (LO)	2700K	3000K	3500K	4000K
Efficacy - Lumens per Watt	40	41	42	42
Lumens per foot (305mm)	136	140	143	145
Watts per foot (305mm)	3.5	3.5	3.5	3.5

Standard Output (SO)	2700K	3000K	3500K	4000K
Efficacy - Lumens per Watt	46	47	48	49
Lumens per foot (305mm)	272	281	286	289
Watts per foot (305mm)	6.0	6.0	6.0	6.0

High Output (HO)	2700K	3000K	3500K	4000K
Efficacy - Lumens per Watt	43	44	45	45
Lumens per foot (305mm)	517	533	544	549
Watts per foot (305mm)	12.3	12.3	12.3	12.3

60° Symmetric (S2)

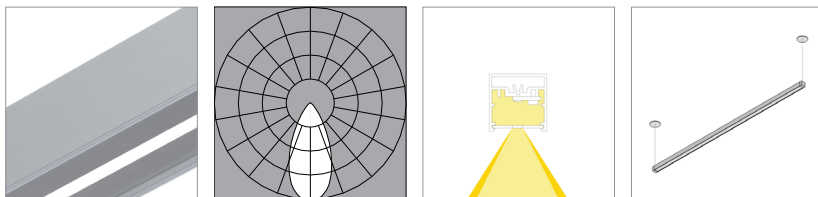

L90 >100,000 hours

90 CRI (90min., 96 avg.)

Low Output (LO)	2700K	3000K	3500K	4000K
Efficacy - Lumens per Watt	54	55	56	57
Lumens per foot (305mm)	183	189	193	195
Watts per foot (305mm)	3.5	3.5	3.5	3.5

Standard Output (SO)	2700K	3000K	3500K	4000K
Efficacy - Lumens per Watt	62	64	65	66
Lumens per foot (305mm)	367	379	386	390
Watts per foot (305mm)	6.0	6.0	6.0	6.0

High Output (HO)	2700K	3000K	3500K	4000K
Efficacy - Lumens per Watt	57	59	60	61
Lumens per foot (305mm)	697	719	734	741
Watts per foot (305mm)	12.3	12.3	12.3	12.3

Performance | Zipper Board Optics

Zipper Board Optics design has 72 diodes per foot (305mm).

85° Asymmetric (A1)

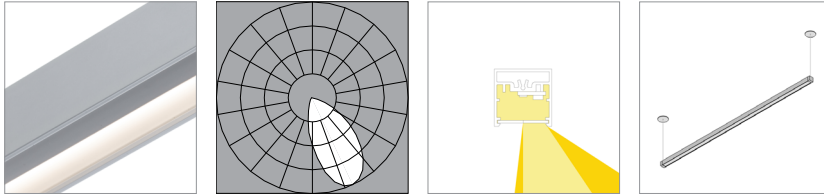

L90 >100,000 hours

90 CRI (90min., 96 avg.)

Low Output (LO)	2700K	3000K	3500K	4000K
Efficacy - Lumens per Watt	55	56	58	58
Lumens per foot (305mm)	187	193	197	199
Watts per foot (305mm)	3.5	3.5	3.5	3.5

Standard Output (SO)	2700K	3000K	3500K	4000K
Efficacy - Lumens per Watt	63	65	67	67
Lumens per foot (305mm)	375	387	395	398
Watts per foot (305mm)	6.0	6.0	6.0	6.0

High Output (HO)	2700K	3000K	3500K	4000K
Efficacy - Lumens per Watt	59	60	62	62
Lumens per foot (305mm)	712	735	750	757
Watts per foot (305mm)	12.3	12.3	12.3	12.3

40° Symmetric, black finish (S1-BL)

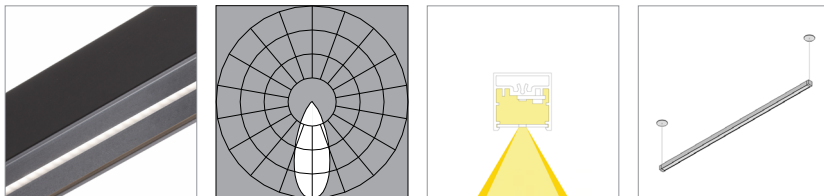

L90 >100,000 hours

90 CRI (90min., 96 avg.)

Low Output (LO)	2700K	3000K	3500K	4000K
Efficacy - Lumens per Watt	29	30	31	31
Lumens per foot (305mm)	99	102	104	105
Watts per foot (305mm)	3.5	3.5	3.5	3.5

Standard Output (SO)	2700K	3000K	3500K	4000K
Efficacy - Lumens per Watt	34	35	35	36
Lumens per foot (305mm)	197	204	208	210
Watts per foot (305mm)	6.0	6.0	6.0	6.0

High Output (HO)	2700K	3000K	3500K	4000K
Efficacy - Lumens per Watt	31	32	33	33
Lumens per foot (305mm)	375	387	395	399
Watts per foot (305mm)	12.3	12.3	12.3	12.3

Performance | Zipper Board Optics

Zipper Board Optics design has 72 diodes per foot (305mm).

60° Symmetric, black finish (S2-BL)

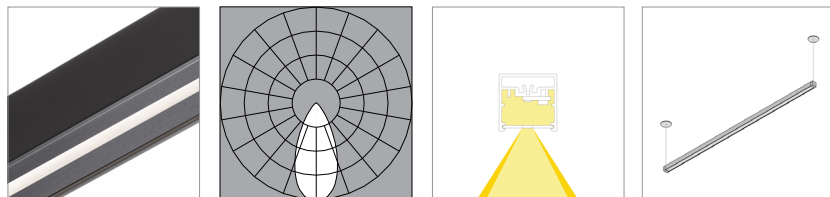

L90 >100,000 hours

90 CRI (90min., 96 avg.)

Low Output (LO)	2700K	3000K	3500K	4000K
Efficacy - Lumens per Watt	34	35	35	36
Lumens per foot (305mm)	115	118	121	122
Watts per foot (305mm)	3.5	3.5	3.5	3.5

Standard Output (SO)	2700K	3000K	3500K	4000K
Efficacy - Lumens per Watt	39	40	41	41
Lumens per foot (305mm)	230	237	242	244
Watts per foot (305mm)	6.0	6.0	6.0	6.0

High Output (HO)	2700K	3000K	3500K	4000K
Efficacy - Lumens per Watt	36	37	38	38
Lumens per foot (305mm)	436	450	459	464
Watts per foot (305mm)	12.3	12.3	12.3	12.3

85° Asymmetric, black finish (A1-BL)

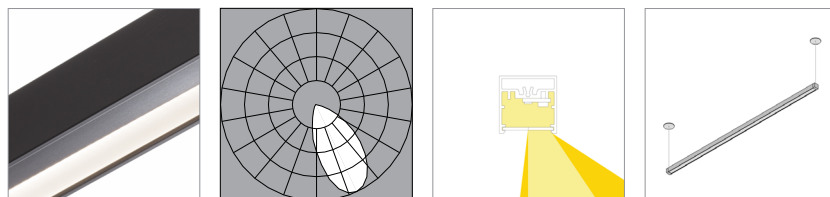

L90 >100,000 hours

90 CRI (90min., 96 avg.)

Low Output (LO)	2700K	3000K	3500K	4000K
Efficacy - Lumens per Watt	44	46	47	47
Lumens per foot (305mm)	152	157	160	162
Watts per foot (305mm)	3.5	3.5	3.5	3.5

Standard Output (SO)	2700K	3000K	3500K	4000K
Efficacy - Lumens per Watt	51	53	54	55
Lumens per foot (305mm)	304	314	320	323
Watts per foot (305mm)	6.0	6.0	6.0	6.0

High Output (HO)	2700K	3000K	3500K	4000K
Efficacy - Lumens per Watt	48	49	50	51
Lumens per foot (305mm)	578	596	608	614
Watts per foot (305mm)	12.3	12.3	12.3	12.3

Copyright © 2025 Vode Lighting LLC. All rights reserved. Vode, the Vode logo, BoxRail, FlyWing, MicroBaffle, Button Board, Zipper Board, Zero Canopy, Zero Block, VodeNODE and other names are either registered trademarks or trademarks of Vode Lighting LLC in the United States and may be registered in other countries. All other trademarks listed herein belong to their respective owners. Due to ongoing innovation, specification details may change without notice.