



Spec Guide

ZipTwo | Square 5020 | Ceiling Cable | 707



Direct or indirect lighting for wall wash and ceiling wash applications.

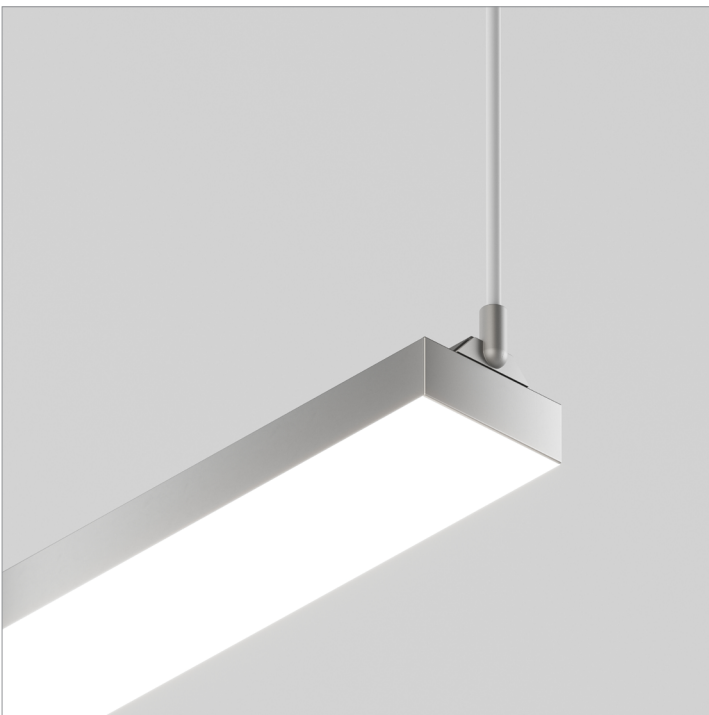

Square 5020, Critical Edge, white

Benefits & Features

Minimal Profile, Robust Design

Rectangular profile. 2" (51mm) x .75" (19mm).

Superior Light Quality & Performance

Output up to 1103 lm/ft (3617 lm/m) (HO), 112 lm/W (HO). 90 CRI & tunable white (2200K-5000K) available.

Adaptive Power Body

Full range dimming power for all protocols. Integral or remote power available. Remote power available up to 100' (30.5m) away.

Floating Plane of Light

Clean lines created by Critical Edge™ optic and a wide luminous surface without diode image.

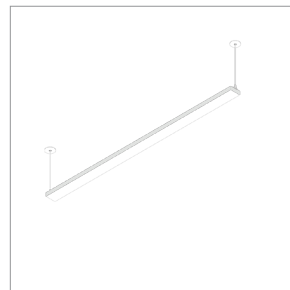

Small Round Canopy



Integral Power

Build Your Specification

707-Z2	S			CC	»
---------------	----------	--	--	-----------	---

System & Rail Type	System Type	System Length	Rail Length	Mounting	Arm/Cord Length
707-Z2 ZipTwo	S Suspended	Specify overall system length in ft/in or M/mm.	24 24" (610mm) 36 36" (914mm) 48 48" (1219mm) 60 60" (1524mm) 72 72" (1829mm) 96 96" (2438mm) 108 108" (2743 mm) 120 120" (3048 mm) 132 132" (3352 mm) 144 144" (3658 mm) ZZ Other rail length or layout (please specify) See Rail Length Chart for more details.	CC Ceiling Cable	48 48" cord (1219mm) 96 96" cord (2438mm) ZZ Other (please specify)

▲ Custom lengths may result in light gaps on the fixture. See [Rail Length Chart](#) for more details.

»			»
---	--	--	---

Power Location	Power Type	Voltage	Emergency Power
Integral Power IP Integral Power Remote Power Specify mounting and harness length code example: 2R25, 2R50 ...etc. Mounting Option 2R Small Round Canopy 4R Large Round Canopy Wire Harness 10 10' (3.048m) Wire Harness 25 25' (7.62m) Wire Harness 50 50' (15.24m) Wire Harness 75 75' (22.86m) Wire Harness 100 100' (30.48m) Wire Harness	Flexible 1 to 1 Power AE 0-10v, 1.0% Dimming AT 0-10v, 0.1% Dimming AD DALI, 0.1% Dimming AX DMX, 100-0% Dimming AH Hi-lume 1% EcoSystem, Soft On / Fade to Black Technology, LDE1 AH2 ELV 1% 2-wire (Forward and Reverse Phase) Optimized Power Add 'O' to power type example: AEO, ATO...etc. ¹ VodeNODE Add 'N' to power type for Flexible 1 to 1 Power Add 'ON' to power type for Optimized Power example: AEN, ATN, AEON, ADON...etc. ² ZZ Other (please specify) See Power Guide for driver features & limitations.	1 120V 2 120V - 277V X Not Yet Specified	0 No Emergency Power ZZ Emergency Power (specify requirements)

Z				»
----------	--	--	--	---

LED Type	Lumen Output	Color Temperature	Optics	Sensors ³
Z Zipper Board	LO Low Output SO Standard Output HO High Output* ZZ Other (please specify) See IES Files page for details. See Power Guide for driver features & limitations.	90+ CRI 27 2700K 30 3000K 35 3500K 40 4000K ZZ Tunable White Available See Guide for details	W5 Square 5020, Critical Edge	0 None ENC Canopy with integrated Enlighted Micro Sensor WSC Canopy with integrated Legrand Wattstopper sensor LAC Canopy with integrated Lutron Athena sensor ZZ Other (please specify)

»	
---	--

Finish	Options
WH White	0 None
BL Black	9 9' 18/3 Cord and Plug
	LLLC Luminaire Level Lighting Controls
	CPS Chicago Plenum Fixture Adapter & Power
	CPP Chicago Plenum Power
	CPA Chicago Plenum Fixture Adapter

NOTES & LIMITATIONS

¹ Optimized Power is not available with Hi-lume 1% EcoSystem (AHO) Power Type.

² VodeNODE enclosure is not available with ELV 1% 2-wire (AH2) Power Type.

³ Sensors, drivers, and control units that are integrated into Vode fixtures are discrete components that communicate with network lighting controls. For more information about each network lighting control system, visit the manufacturer's website for additional system information and technical data sheets.

For general information about network lighting controls, consult the DesignLights Consortium® (DLC) [Networked Lighting Control Qualified Product List](#)

Listed to UL standards for damp location by a Nationally Recognized Testing Laboratory (NRTL) recognized by OSHA. Certain limitations exist for each Certification. Contact factory for verification.

Standard 5 Year Limited Warranty. See details [here](#). Contact factory for options on Limited Warranties up to 20 years.



Applications

General Interior and Open Office



Square 5020, Critical Edge



Square 5020, Critical Edge

Sustainability & Certifications

DECLARE

International Living Future Institute (ILFI)

Red List Approved

All Vode Lighting linear light fixtures proudly carry the Red List Approved designation.



Declare.

Vode Adaptive Architectural Lighting Systems Vode Lighting LLC

Final Assembly: Sonoma, California, US
Life Expectancy: 10+ Year(s)
End of Life Options: Recyclable (100%)

Ingredients:

Steel; Anodized Aluminum (6063-T5 Alloy); Small Electrical Component (RoHS); Copper; **Fluorinated Ethylene Propylene (masterbatch)**; Polymethyl methacrylate (PMMA); Stainless Steel; Polyoxymethylene Copolymer (POM); Styrene-butadiene polymer, hydrogenated; Poly(methyl methacrylate/butyl acrylate/styrene) (PMMA/BA/S); Styrene/butadiene copolymer; Distillates; Polypropylene; Calcium carbonate; Polycarbonate; EVA Copolymer; Methyl methacrylate (MMA); Polyphenylene Oxide; Brass; Tin, Organic

Living Building Challenge Criteria: Compliant

I-13 Red List:

- LBC Red List Free % Disclosed: 100% at 100ppm
- LBC Red List Approved VOC Content: Not Applicable
- Declared

I-10 Interior Performance: Not Applicable

I-14 Responsible Sourcing: Not Applicable

VDE-0001
EXP. 01 FEB 2026
Original Issue Date: 2018

MANUFACTURER RESPONSIBLE FOR LABEL ACCURACY
INTERNATIONAL LIVING FUTURE INSTITUTE™ living-future.org/declare

Click here to learn more: International Living Future Institute

TM65NA

CIBSE & ASHRAE on Embodied Carbon

Vode recognizes TM65NA as the highest standard for understanding the embodied carbon of our fixtures.

Developed with ASHRAE, it adapts CIBSE's TM65 for North America, ensuring accurate regional assessments. It must be used alongside TM65 and follows TM65LA's framework.

System: 707 | ZipTwo | Ceiling Cable
Embodied Carbon (kg CO₂e): 36.89*

***Note:** Embodied Carbon, expressed in kilograms of CO₂e is calculated using a 48" fixture **and includes the LED driver.**



Click here to learn more [CIBSE](#), [ASHRAE](#).

BAA X BABA

Buy American Act / Build America & Buy America Act Compliance

Vode is dedicated to supporting domestic manufacturing and ensuring compliance with BAA and BABA requirements.

Given the complexity of our products, we recommend reaching out to vodecares@vode.com for confirmation regarding compliance for your specific project.



Click here to learn more: US Department of Commerce

Structure

Rail Lengths	24" (610mm) - 144" (3658mm). Modified lengths available. See Rail Length Chart for more details.
Rail Dimensions	2" (51mm) x 1.44" (37mm) x length.
Construction	Extruded and machined 6063 aluminum.
Mounting	Ceiling mount to jbox or driver housing.
Cable Length	48" (1220mm) and 96" (2438mm) available. Field adjustable. Non-standard cable lengths available.
System Run Length	24" (610mm) minimum. Unlimited maximum.
Operating Temperature	32°F to 104°F (0°C to 40°C).
Humidity	0-85%, non-condensing.
System Weight	0.11kg per foot (xx kg per 305mm) Power supply and housing not included.

Materials

LED Board Construction	Aluminum core PCB, black LCP connectors, RoHS compliant.
Lens	High-impact extruded acrylic glass (PMMA).
Suspension Cable	Ø4mm, 22/4 AWG, TPE jacket, FEP-insulated, Red List Approved.
Power Cable	Ø3mm, 33/2 AWG, Plenum (CMP) rated semi-rigid PVC or FEP, flame tested UL-910, Red List Approved.
Cable Connectors	Unfilled black nylon, rated UL 94 V-0, halogen free, PVC or FEP overmold, RoHS compliant, Red List Approved.
Remote Linear Power Housing	20.7" x 2.375" x 2.53", 0.054" formed Galvanized Steel.
Remote Brick Power Housing	4.32" x 3.37" x .078" Galvanized Steel mounting plate.
Integral Power Housing	extruded and machined 6063 aluminum.
Center Cable Suspension	3/64" aircraft cable.

Mounting Options

Remote Power

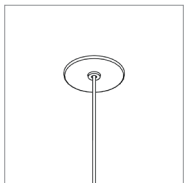

Small Round Canopy
Ø2.5" (51mm)

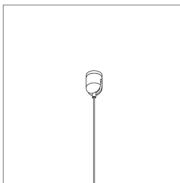

Center Support Cable
108" - 144" Rails Only
Center Support Cable for mounting to T-Bar tile available.

Integral Power (24"-72")

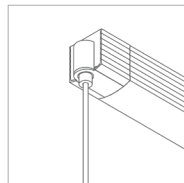

Integral Power (end)
h 1.8" (46mm)
w 1.7" (43mm)

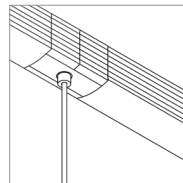

Integral Power (joint)

Dimensions

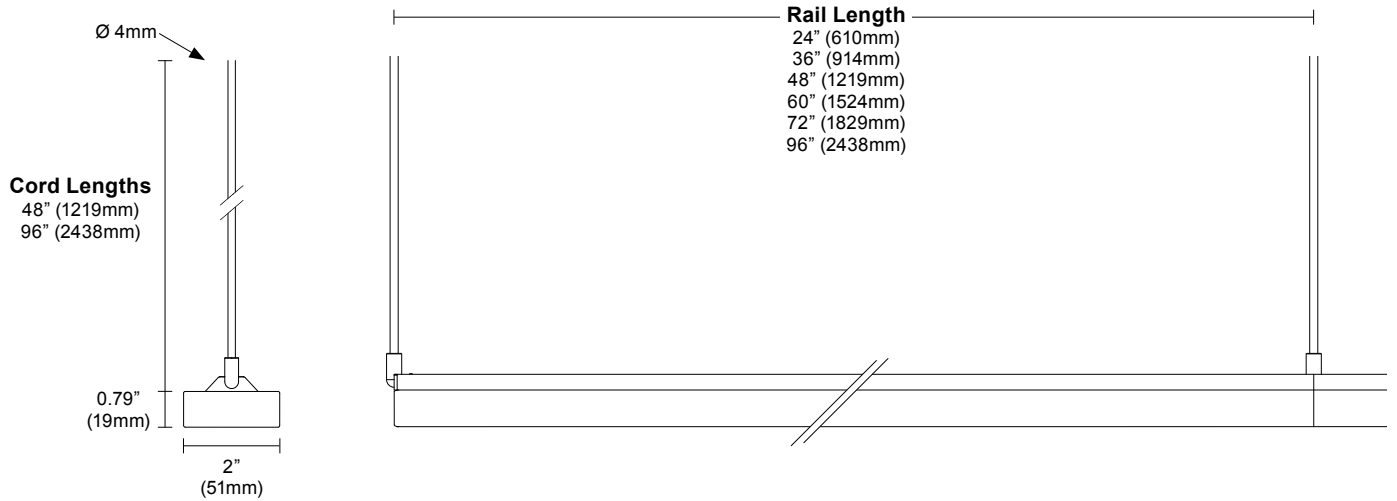

Layout

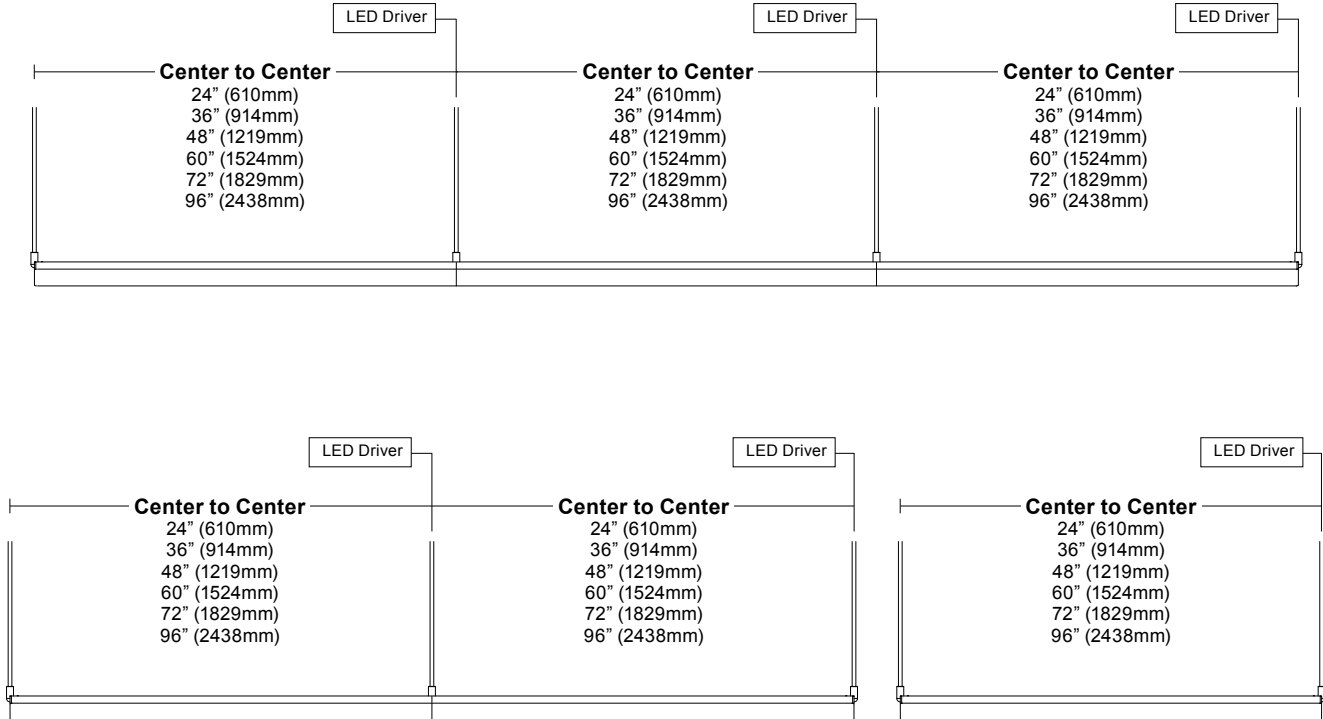

Corner and Shapes Available (Square, Rectangle, L-Shape, U-Shape, ZigZag) [See Guide](#) for details.

Dimensions

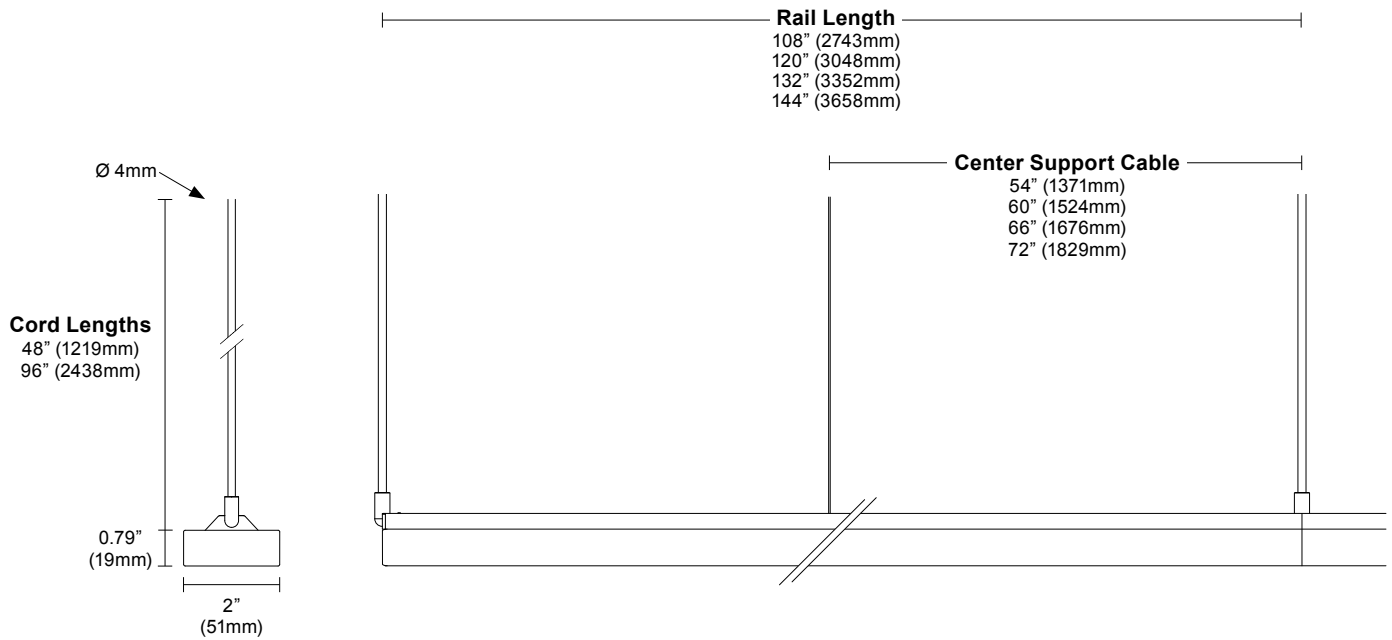

Layout

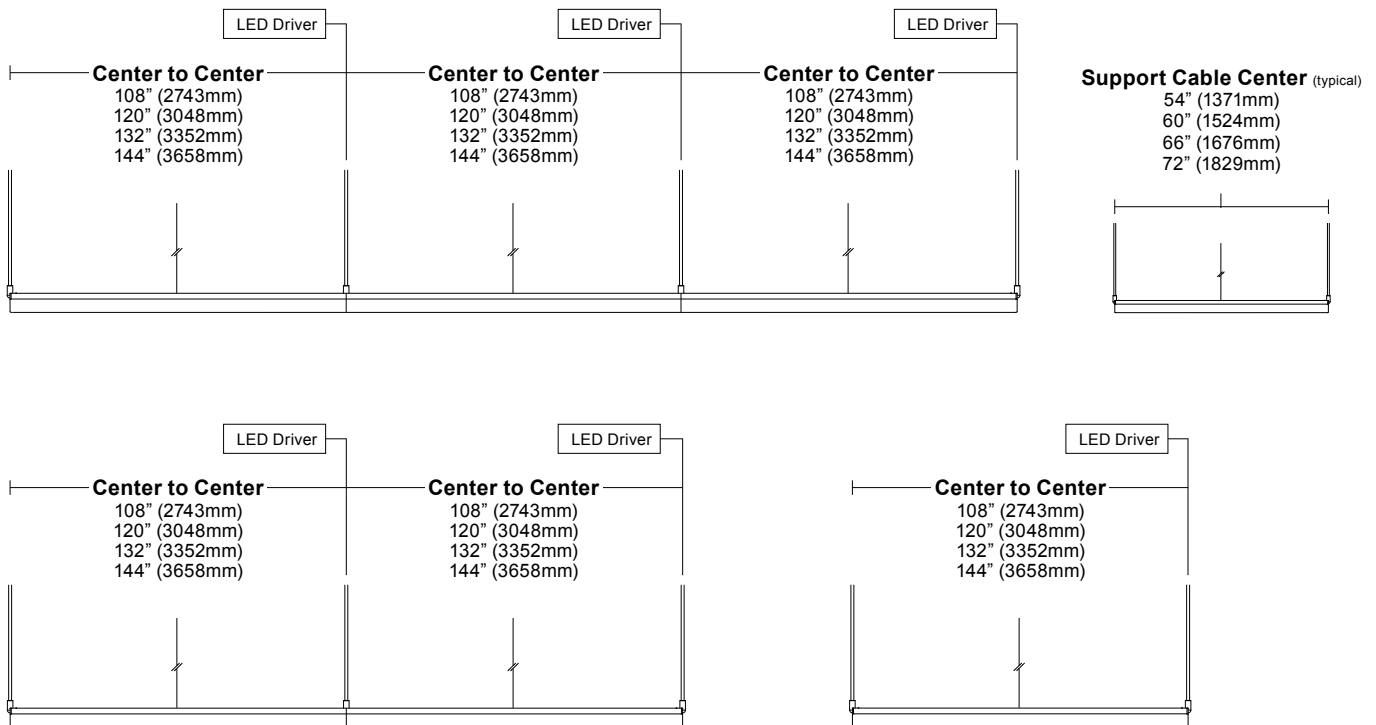

Corner and Shapes Available (Square, Rectangle, L-Shape, U-Shape, ZigZag) [See Guide](#) for details.

vodeCONNECT Sensors

Canopy with integrated sensor

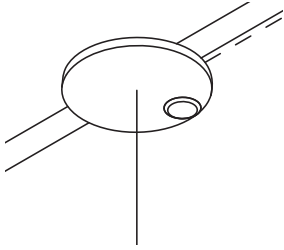

Sensor partners



Integrated canopy sensor layout ¹

1 sensor per fixture. See [vodeCONNECT brochure](#) for more details.

NOTES: 1. Available with Large Round Canopy only.

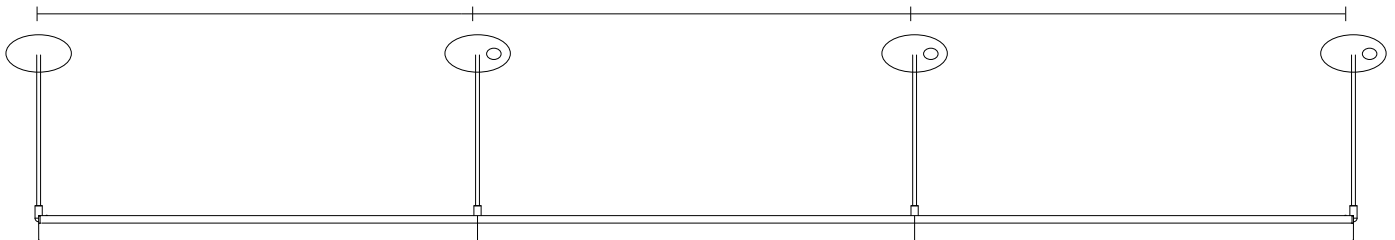

Compatible sensors



Lutron Athena



Legrand Wattstopper



Enlighted Micro Sensor

Power and Controls

Power Type	Class 2 (<60V output) constant current driver.
Dimming Controls	Dimming (0.1%, 1%), 0-10V, DALI, DMX, Hi-lume 1% are available. See Power Guide for details.
Input Voltage	120V - 277V, 50/60hz.
Power Location	Remote power. Maximum remote distance up to 100' (30.5m) depending on driver selection. See Power Guide for details.

Remote power is locating the power supply away from the fixture. Remote power comes in two housing styles: brick style and linear style. Consult [Power Guide](#) to determine which type you will receive.

Remote Brick Power Housing

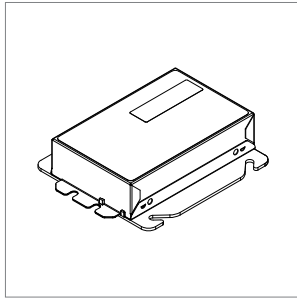

Supplied for some remote power applications. One remote power supply housing is supplied for each rail. Provided driver mounting plate fits standard 4" metal, square J-Boxes with a minimum volume of 21 in³ (J-Box not provided). See [Tech Sheet](#) for details.

Remote Linear Power Housing

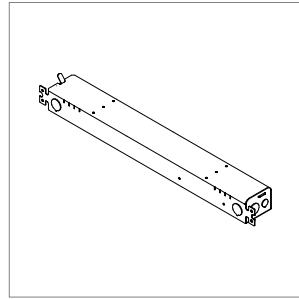

One remote power supply housing is supplied with each power supply. All Vode linear remote drivers come in a 0.054" (0.8mm) formed galvanized steel power supply housing with five (5) knockouts: (4) 1-1/8", (1) 7/8" and (1) 9/16". Accommodates standard linear power supplies. See [Tech Sheet](#) for details.

Integral Power

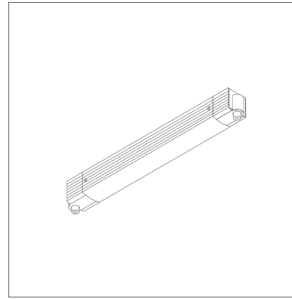

Houses integral power supply. Direct conduit feed is recommended, but integral power supply housing will mount to any standard North America 4" j-box. Mounts to most surfaces. Blocking is recommended at all arm junctions. See [Tech Sheet](#) for details.

Wire Harness

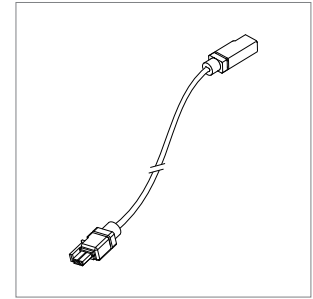

Wire harness connects driver to rail section. Lengths of 10' (3.0m) & 25' (7.6m) with snap-lock connectors for quick and easy installation. Multiple harnesses may be combined for lengths up to 100' (30.5m). See [Tech Sheet](#) for details.

Power and Controls

Flexible 1 to 1 power

For Flexible 1 to 1 Power, Vode supplies one single output driver per fixture, allowing each fixture to be controlled independently. Direct/Indirect fixtures are supplied with two single output drivers, allowing the direct and indirect lighting to be controlled independently. Consult [Power Guide](#) to determine which type you will receive.

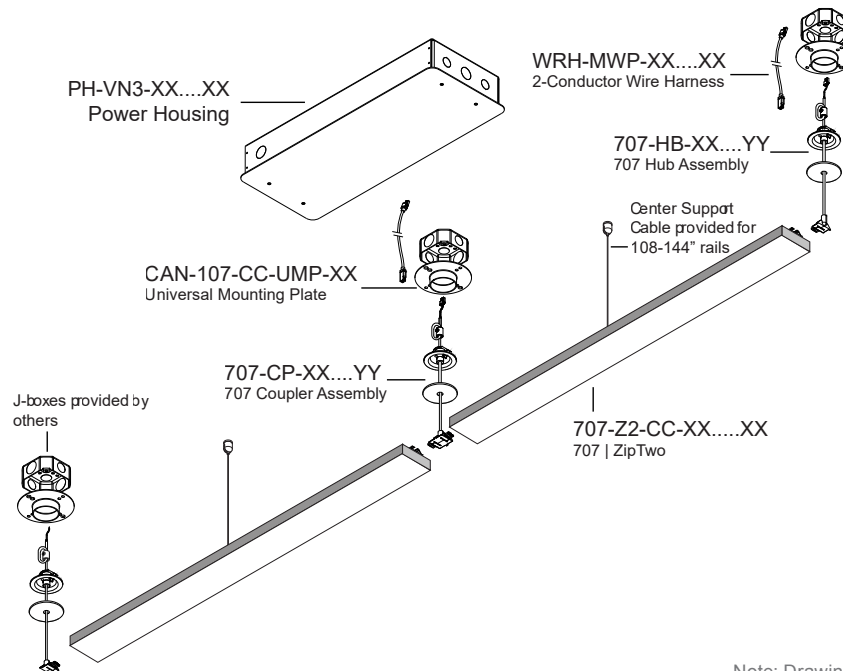

Note: Drawings not to scale, for reference only.

Optimized Power

To optimize power, Vode configures specifications with drivers that have 2 or 4 outputs. Depending on system configurations and power requirements, up to 4 fixtures can be powered from a 4-output driver. Consult [Power Guide](#) to determine which type you will receive.

IMPORTANT: Each fixture will still require individual wire harnesses, as shown below.

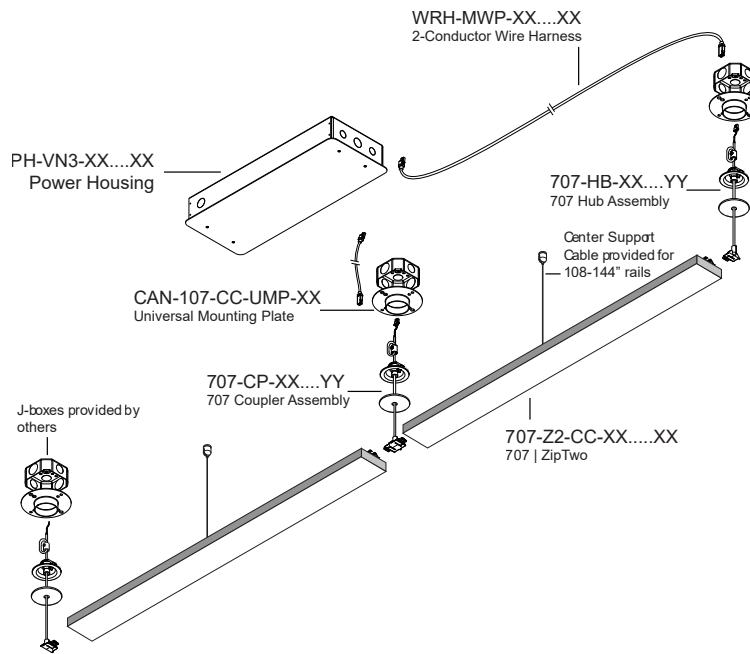

Finish

White Finish

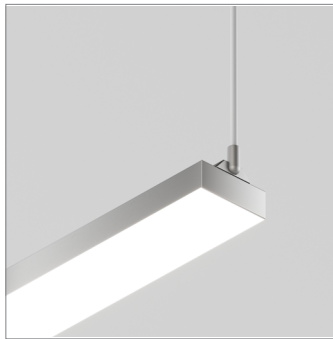

White Rail, White Canopy/Integral Power, White Cable

Black Finish

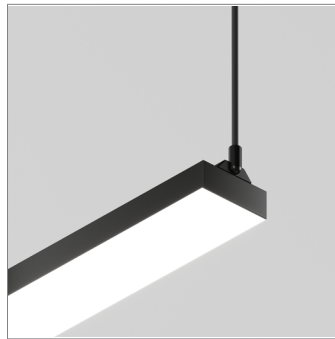

Black Rail, Black Canopy/Integral Power, Black Cable

Note: Drawings not to scale, for reference only.

Performance | Zipper Board Optics

Zipper Board Optics design has 72 diodes per foot (305mm).

Square 5020, Critical Edge, white finish (W5-WH)

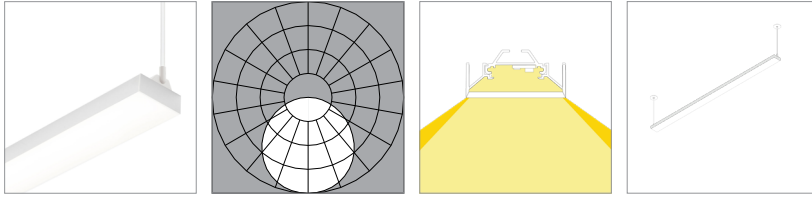

L90 >100,000 hours

90 CRI (90min., 96 avg.)

Low Output (LO)	2700K	3000K	3500K	4000K
Efficacy - Lumens per Watt	75	78	79	80
Lumens per foot (305mm)	279	288	294	296
Watts per foot (305mm)	3.8	3.8	3.8	3.8

Standard Output (SO)	2700K	3000K	3500K	4000K
Efficacy - Lumens per Watt	86	88	90	91
Lumens per foot (305mm)	558	575	587	593
Watts per foot (305mm)	6.6	6.6	6.6	6.6

High Output (HO)	2700K	3000K	3500K	4000K
Efficacy - Lumens per Watt	85	88	90	90
Lumens per foot (305mm)	836	863	881	889
Watts per foot (305mm)	9.9	9.9	9.9	9.9

Square 5020, Critical Edge, black finish (W5-BL)

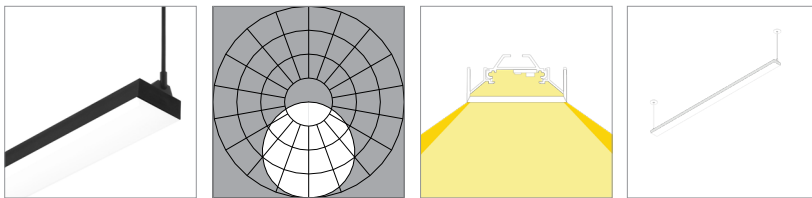

L90 >100,000 hours

90 CRI (90min., 96 avg.)

Low Output (LO)	2700K	3000K	3500K	4000K
Efficacy - Lumens per Watt	60	62	63	64
Lumens per foot (305mm)	222	229	233	236
Watts per foot (305mm)	3.8	3.8	3.8	3.8

Standard Output (SO)	2700K	3000K	3500K	4000K
Efficacy - Lumens per Watt	68	70	72	73
Lumens per foot (305mm)	443	457	467	471
Watts per foot (305mm)	6.6	6.6	6.6	6.6

High Output (HO)	2700K	3000K	3500K	4000K
Efficacy - Lumens per Watt	68	70	71	72
Lumens per foot (305mm)	665	686	700	707
Watts per foot (305mm)	9.9	9.9	9.9	9.9

Copyright © 2025 Vode Lighting LLC. All rights reserved. Vode, the Vode logo, BoxRail, FlyWing, MicroBaffle, Button Board, Zipper Board, Zero Canopy, Zero Block, VodeNODE and other names are either registered trademarks or trademarks of Vode Lighting LLC in the United States and may be registered in other countries. All other trademarks listed herein belong to their respective owners. Due to ongoing innovation, specification details may change without notice.