



Spec Guide

ZipTwo | Micro 3508 | 707



Direct lighting for open office, wall wash and grazing applications.



Micro 3508, 85° Asymmetric, white

Benefits & Features

Micro Profile, Robust Design

Flat profile. 1.38" (35mm) x 0.31" (8mm).

Superior Light Quality & Performance

Output up to 1575 lm/ft (5168 lm/m) (HO), 161 lm/W (HO). 80 or 90 CRI & tunable white (2200K-5000K) available.

Versatile Mounting Options, Easy Installation

Magnet with tape-on metal strip or low profile clip allow for mounting to almost any surface or T-Bar ceiling.

Better Optics & Beam Control

Options of Diffuse, 120°, 60°, 40° and 85° (asymmetric) lens for general illumination, grazing or wall wash. Excellent glare control with optical film and MicroBaffle™.

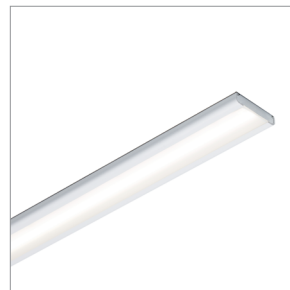

Micro 3508, 120° Symmetric, white



Micro 3508, 40° Symmetric, black

Build Your Specification

707-Z2	SL				0 ▶▶
--------	----	--	--	--	------

System & Rail Type	System Type	System Length	Rail Length	Mounting	Arm/Cord Length
707-Z2 ZipTwo	SL Standard Linear	Specify overall system length in ft/in or M/mm. <i>Corner and Shapes Available See Guide for details.</i>	24 24" (610mm) 36 36" (914mm) 48 48" (1219mm) 60 60" (1524mm) 72 72" (1829mm) 96 96" (2438mm) 108 108" (2743mm) 120 120" (3048mm) 132 132" (3352mm) 144 144" (3658mm) ZZ Other rail length or layout (please specify) <i>See Rail Length Chart for more details.</i>	C Clip CM Clip with Micro J-Box ¹ T Magnet with Tape-On Metal Strip ² T1 9/16" T-Bar Clip, low profile T2 15/16" T-Bar Clip, low profile T3 15/16" T-Bar Clip, medium profile T4 15/16" T-Bar Clip, concealed T5 9/16" T-Bar Clip, medium profile T6 Slotted T-Bar Clip T7 Dimensional T-Bar Clip SC Strut Channel Clip ¹ DM Armstrong DynaMax ZZ Other (please specify)	0 None

▲ Custom lengths may result in light gaps on the fixture. See Rail Length Chart for more details.

▶▶				Z
----	--	--	--	---

Power Location	Power Type	Voltage	Emergency Power	LED Type
Remote Power	Flexible 1 to 1 Power	1 120V 2 120V - 277V X Not Yet Specified	0 No Emergency Power ZZ Emergency Power (<i>specify requirements</i>)	Z Zipper Board ZZ Zipper Board
RP10 10' (3.048m) Wire Harness RP25 25' (7.62m) Wire Harness RP50 50' (15.24m) Wire Harness RP75 75' (22.86m) Wire Harness RP100 100' (30.48m) Wire Harness	AE 0-10V, 1.0% Dimming AT 0-10V, 0.1% Dimming AD DALI, 0.1% Dimming AX DMX, 100-0% Dimming AH Hi-lume 1% EcoSystem, Soft On / Fade to Black Technology, LDE ¹ AH2 ELV 1% 2-wire (Forward and Reverse Phase)			
	Optimized Power Add 'O' to power type example: AEO, ATO...etc. ³ VodeNODE Add 'N' to power type for Flexible 1 to 1 Power Add 'ON' to power type for Optimized Power example: AEN, ATN, AEON, ADON...etc. ⁴ ZZ Other (please specify) <i>See Power Guide for driver features & limitations.</i>			

▶▶				
----	--	--	--	--

Lumen Output	Color Temperature	Optics	Sensors	Finish
LO Low Output SO Standard Output HO High Output ZZ Other (please specify) <i>See IES Files page for details.</i> <i>See Power Guide for driver features & limitations.</i>	90+ CRI 27 2700K 30 3000K 35 3500K 40 4000K RGBW 90+ CRI C279 RGB Color, 2700K C309 RGB Color, 3000K C359 RGB Color, 3500K C409 RGB Color, 4000K ZZ Tunable White Available <i>See Guide for details.</i>	A1 Micro 3508, 85° Asymmetric S1 Micro 3508, 40° Symmetric S2 Micro 3508, 60° Symmetric S3 Micro 3508, 120° Symmetric D3 Micro 3508, High Lumen ⁵ D4 Micro 3508, High Lumen with MicroBaffle ⁵	0 None ZZ Other (please specify) ⁶	WH White BL Black

NOTES & LIMITATIONS

¹ Mounting type available with Chicago Plenum.
² Custom modification available for Chicago Plenum. Contact factory.
³ Optimized Power is not available with Hi-lume 1% EcoSystem (AHO) Power Type.
⁴ VodeNODE enclosure is not available with ELV 1% 2-wire (AH2) Power Type.
⁵ High Lumen (D3) and High Lumen with MicroBaffle (D4) are only available in White Finish (WH).
⁶ Sensors are available please contact Vode for more information.

▶▶

- Options**
- 0** None
 - 9** 9' 18/3 Cord and Plug
 - CPS** Chicago Plenum Fixture Adapter & Power
 - CPP** Chicago Plenum Power
 - CPA** Chicago Plenum Fixture Adapter

Listed to UL standards for damp location by a Nationally Recognized Testing Laboratory (NRTL) recognized by OSHA. Certain limitations exist for each Certification. Contact factory for verification.

Standard 5 Year Limited Warranty. See details [here](#). Contact factory for options on Limited Warranties up to 20 years.



Applications

General Interior and Open Office



Paul Hastings, Los Angeles, CA



Christie's Auction House, Los Angeles, CA



Booz Allen Hamilton, Washington, DC

Applications

General Interior and Open Office



Tuck Hinton Architects, Nashville, TN

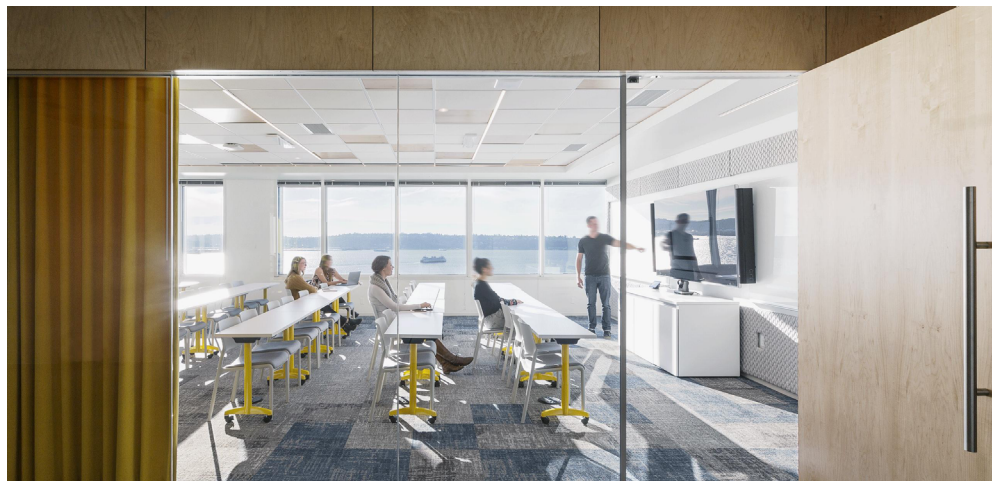

Tech/Media Client, Seattle, WA

Sustainability & Certifications

DECLARE

International Living Future Institute (ILFI)

Red List Approved

All Vode Lighting linear light fixtures proudly carry the Red List Approved designation.



Declare.

Vode Adaptive Architectural Lighting Systems Vode Lighting LLC

Final Assembly: Sonoma, California, US
Life Expectancy: 10+ Year(s)
End of Life Options: Recyclable (100%)

Ingredients:

Steel; Anodized Aluminum (6063-T5 Alloy); Small Electrical Component (RoHS); Copper; **Fluorinated Ethylene Propylene (masterbatch)**; Polymethyl methacrylate (PMMA); Stainless Steel; Polyoxymethylene Copolymer (POM); Styrene-butadiene polymer, hydrogenated; Poly(methyl methacrylate/butyl acrylate/styrene) (PMMA/BA/S); Styrene/butadiene copolymer; Distillates; Polypropylene; Calcium carbonate; Polycarbonate; EVA Copolymer; Methyl methacrylate (MMA); Polyphenylene Oxide; Brass; Tin, Organic

Living Building Challenge Criteria: Compliant

I-13 Red List:

- LBC Red List Free % Disclosed: 100% at 100ppm
- LBC Red List Approved VOC Content: Not Applicable
- Declared

I-10 Interior Performance: Not Applicable

I-14 Responsible Sourcing: Not Applicable

VDE-0001
EXP. 01 FEB 2026
Original Issue Date: 2018

MANUFACTURER RESPONSIBLE FOR LABEL ACCURACY
INTERNATIONAL LIVING FUTURE INSTITUTE™ living-future.org/declare

Click here to learn more: International Living Future Institute

TM65NA

CIBSE & ASHRAE on Embodied Carbon

Vode recognizes TM65NA as the highest standard for understanding the embodied carbon of our fixtures.

Developed with ASHRAE, it adapts CIBSE's TM65 for North America, ensuring accurate regional assessments. It must be used alongside TM65 and follows TM65LA's framework.

System: 707 | ZipTwo | Surface
Embodied Carbon (kg CO₂e): 28.63*

***Note:** Embodied Carbon, expressed in kilograms of CO₂e is calculated using a 48" fixture and includes the LED driver.



Click here to learn more [CIBSE](#), [ASHRAE](#).

BAA X BABA

Buy American Act / Build America & Buy America Act Compliance

Vode is dedicated to supporting domestic manufacturing and ensuring compliance with BAA and BABA requirements.

Given the complexity of our products, we recommend reaching out to vodecares@vode.com for confirmation regarding compliance for your specific project.



Click here to learn more: US Department of Commerce

Structure

Rail Lengths	24" (610mm) - 144" (3658mm). Modified lengths available. See Rail Length Chart for more details.
Rail Dimensions	1.38" (35mm) x 0.31" (8mm) x length.
Construction	Extruded and machined 6063 aluminum.
Mounting	Clip, Clip with Micro J-Box, Magnet with Tape-On Metal Strip, T-Bar Clips for most grid/panel construction, Strut Channel Clip.
System Run Length	24" (610mm) minimum. Unlimited maximum.
Operating Temperature	32°F to 104°F (0°C to 40°C).
Humidity	0-95%, non-condensing. Suitable for damp locations.
System Weight	0.15lbs per ft (0.07kg per 305mm). Power supply and housing not included.

Materials

LED Board Construction	Aluminum core PCB, black LCP connectors, RoHS compliant.
Lens	High-impact extruded acrylic glass (PMMA).
Power Cable	Ø3mm, 33/2 AWG, Plenum (CMP) rated semi-rigid PVC or FEP, flame tested UL-910 (<i>PVC free in 2020</i>).
Cable Connectors	Unfilled black nylon, rated UL 94 V-0, halogen free, PVC or FEP overmold, RoHS compliant (<i>PVC free in 2020</i>).
Remote Linear Power Housing (RLP)	20.7" x 2.375" x 2.53", 0.054" formed Galvanized Steel.
Remote Brick Power Housing (RBP)	4.32" x 3.37" x .078" Galvanized Steel mounting plate.

Power and Controls

Power Type	Class 2 (<60V output) constant current driver.
Dimming Controls	Dimming (0.1%, 1%), 0-10V, DALI, DMX, Hi-lume 1% are available. See Power Guide for details.
Input Voltage	120V - 277V, 50/60hz.
Power Location	Remote power. Maximum remote distance up to 100' (30.5m) <i>depending</i> on driver selection. See Power Guide for details.

Remote power is locating the power supply away from the fixture. Remote power comes in two housing styles: brick style and linear style. Consult [Power Guide](#) to determine which type you will receive.

Remote Brick Power Housing

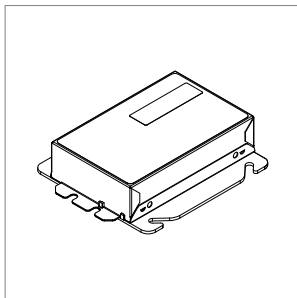

Supplied for some remote power applications. One remote power supply housing is supplied for each rail. Provided driver mounting plate fits standard 4" metal, square J-Boxes with a minimum volume of 21 in³ (J-Box not provided). See [Tech Sheet](#) for details.

Remote Linear Power Housing

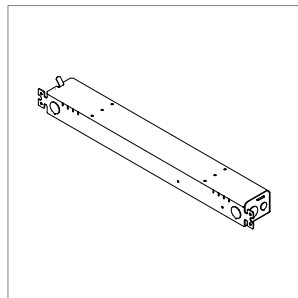

One remote power supply housing is supplied with each power supply. All Vode linear remote drivers come in a 0.054" (0.8mm) formed galvanized steel power supply housing with five (5) knockouts: (4) 1-1/8", (1) 7/8" and (1) 9/16". Accommodates standard linear power supplies. See [Tech Sheet](#) for details.

Wire Harness

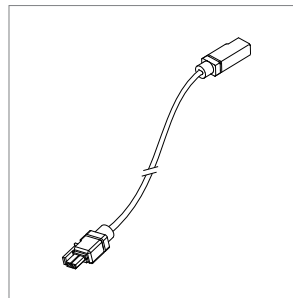

Wire harness connects driver to rail section. Lengths of 10' (3.0m) & 25' (7.6m) with snap-lock connectors for quick and easy installation. Multiple harnesses may be combined for lengths up to 100' (30.5m). See [Tech Sheet](#) for details.

Power and Controls

Flexible 1 to 1 power

For Flexible 1 to 1 Power, Vode supplies one single output driver per fixture, allowing each fixture to be controlled independently. Direct/Indirect fixtures are supplied with two single output drivers, allowing the direct and indirect lighting to be controlled independently. Consult [Power Guide](#) to determine which type you will receive.

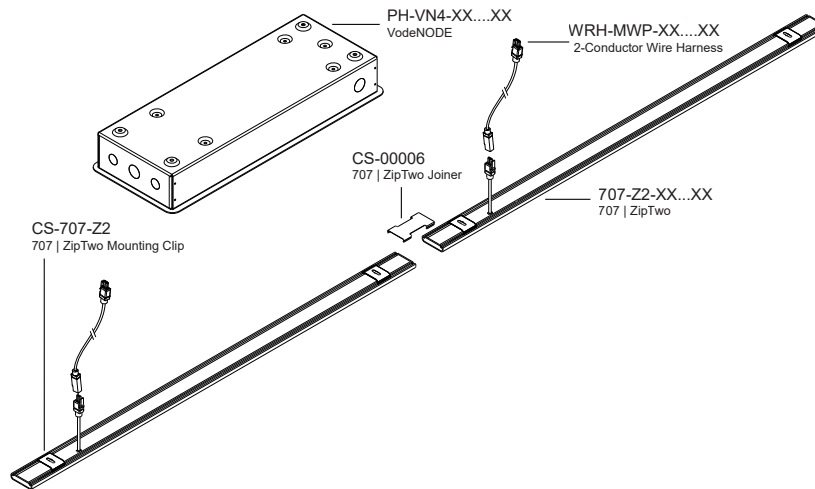

Optimized Power

To optimize power, Vode configures specifications with drivers that have 2 or 4 outputs. Depending on system configurations and power requirements, up to 4 fixtures can be powered from a 4-output driver. Consult [Power Guide](#) to determine which type you will receive.

IMPORTANT: Each fixture will still require individual wire harnesses, as shown below.

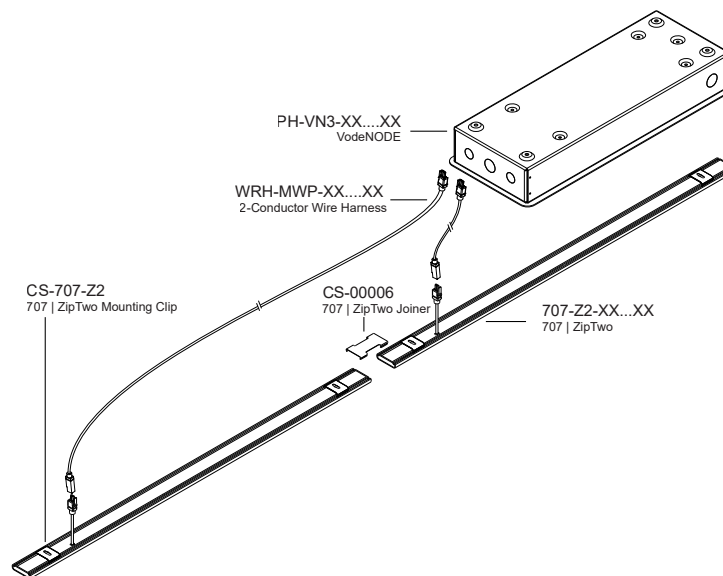

Note: Drawings not to scale, for reference only.

Dimensions

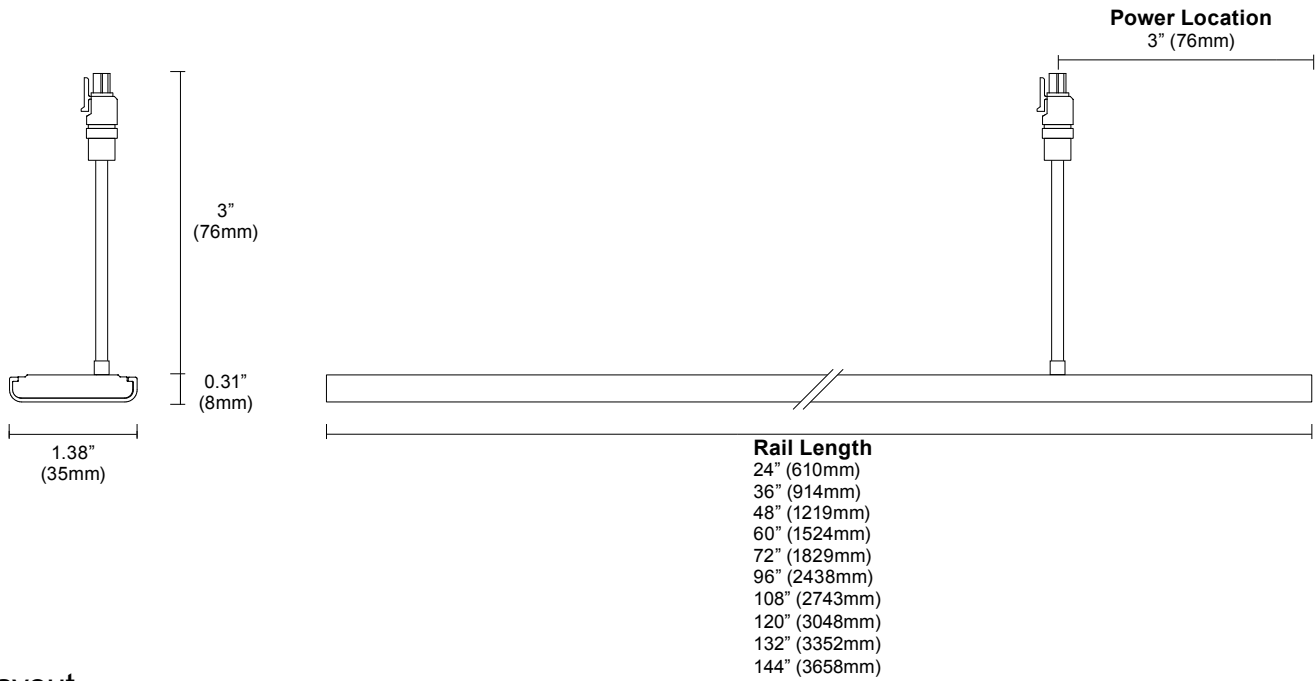

Layout

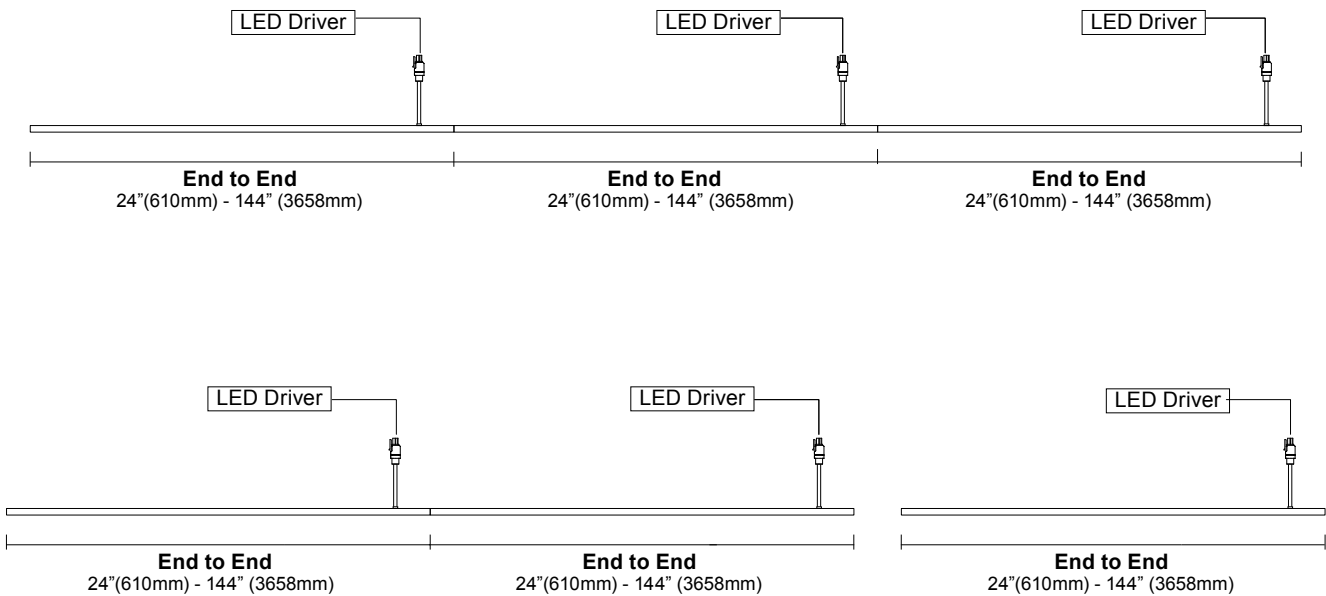

Corner and Shapes Available (Square, Rectangle, L-Shape, U-Shape, ZigZag) [See Guide](#) for details.

Mounting Options

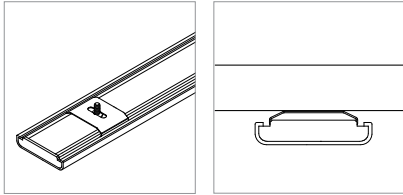

Clip (C)

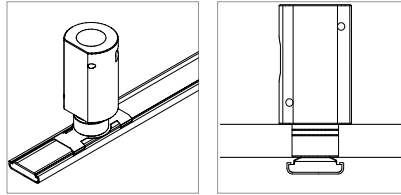

Clip with Micro J-Box (CM)

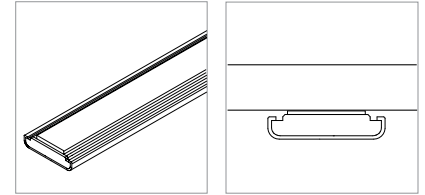

Magnet with Tape-On Metal Strip (T)

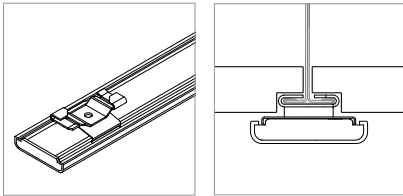

9/16" T-Bar Clip, low profile (T1)

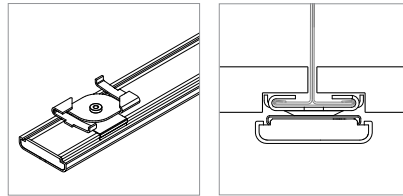

15/16" T-Bar Clip, low profile (T2)

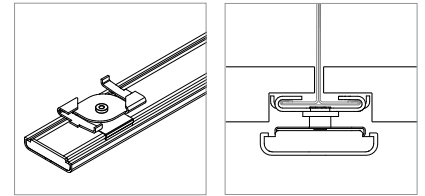

15/16" T-Bar Clip, medium profile (T3)

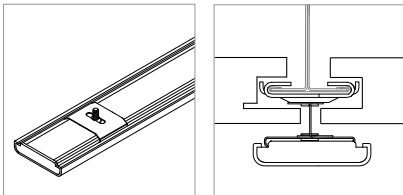

15/16" T-Bar Clip, concealed (T4)

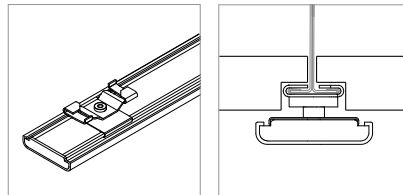

9/16" T-Bar Clip, medium profile (T5)

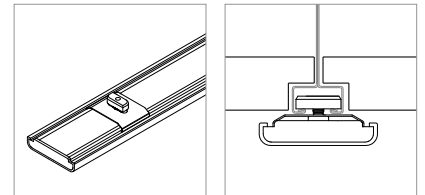

Slotted T-Bar Clip (T6)

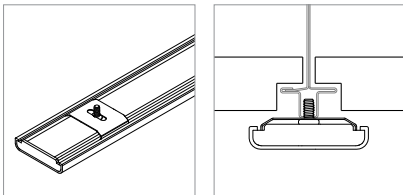

Dimensional T-Bar Clip (T7)

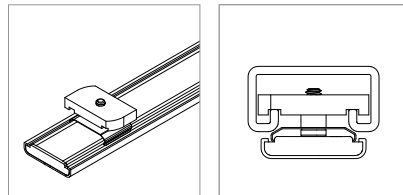

Strut Channel Clip (SC)

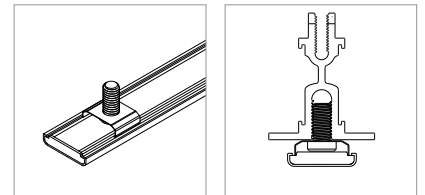

Armstrong DynaMax (DM)

See [ZipTwo Clip Guide](#) to check compatibility.

Performance | Zipper Board Optics

Zipper Board Optics design has 72 diodes per foot (305mm).

Micro 3508, 40° Symmetric, white finish (S1-WH)

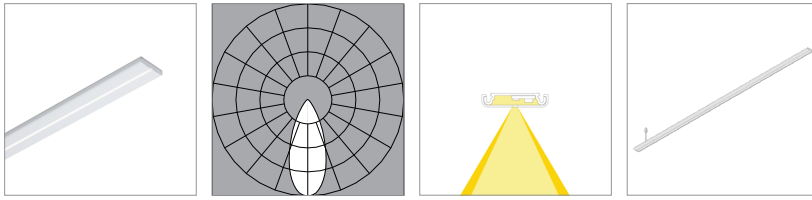

L80 >60,000 hours

90 CRI (90min., 96 avg.)

Low Output (LO)	2700K	3000K	3500K	4000K
Efficacy - Lumens per Watt	45	47	48	48
Lumens per foot (305mm)	167	172	175	177
Watts per foot (305mm)	3.8	3.8	4	3.8

Standard Output (SO)	2700K	3000K	3500K	4000K
Efficacy - Lumens per Watt	52	53	54	55
Lumens per foot (305mm)	333	344	351	354
Watts per foot (305mm)	6.6	6.6	6.6	6.6

High Output (HO)	2700K	3000K	3500K	4000K
Efficacy - Lumens per Watt	51	53	54	54
Lumens per foot (305mm)	500	515	526	531
Watts per foot (305mm)	9.9	9.9	9.9	9.9

Micro 3508, 60° Symmetric, white finish (S2-WH)

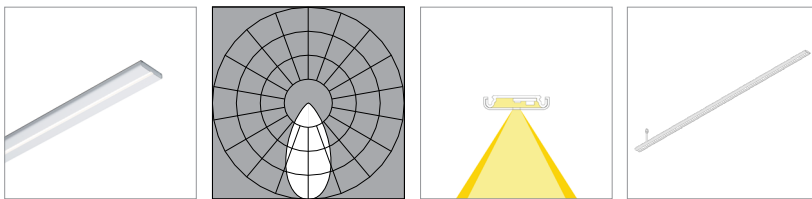

L80 >60,000 hours

90 CRI (90min., 96 avg.)

Low Output (LO)	2700K	3000K	3500K	4000K
Efficacy - Lumens per Watt	69	71	73	74
Lumens per foot (305mm)	256	264	269	272
Watts per foot (305mm)	3.5	3.5	3.5	3.5

Standard Output (SO)	2700K	3000K	3500K	4000K
Efficacy - Lumens per Watt	79	81	83	84
Lumens per foot (305mm)	512	528	539	544
Watts per foot (305mm)	6.0	6.0	6.0	6.0

High Output (HO)	2700K	3000K	3500K	4000K
Efficacy - Lumens per Watt	78	81	82	83
Lumens per foot (305mm)	768	792	808	816
Watts per foot (305mm)	12.3	12.3	12.3	12.3

Performance | Zipper Board Optics | RGBW

Zipper Board Optics design has 72 diodes per foot (305mm).
 RGBW (red, green, blue, and white) tested with **all channels on**.

Micro 3508, 40° Symmetric, white finish (S1-WH)

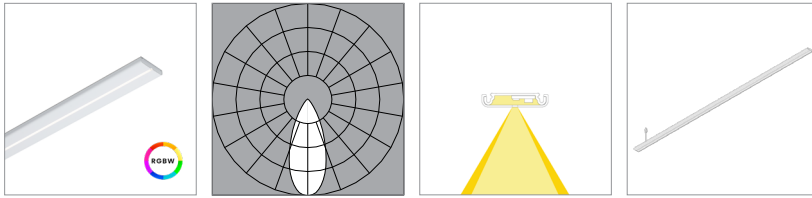

L80 >60,000 hours

RGBW Color, 90 CRI (90min., 96 avg.)

Low Output (LO)	2700K 3000K 3500K 4000K			
	Efficacy - Lumens per Watt	27	28	29
Lumens per foot (305mm)	226	233	238	241
Watts per foot (305mm)	8.5	8.5	8.5	8.5

Standard Output (SO)	2700K 3000K 3500K 4000K			
	Efficacy - Lumens per Watt	26	27	27
Lumens per foot (305mm)	339	350	357	361
Watts per foot (305mm)	13.3	13.3	13.3	13.3

Micro 3508, 60° Symmetric, white finish (S2-WH)

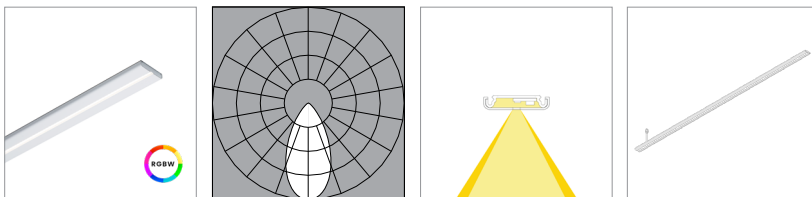

L80 >60,000 hours

RGBW Color, 90 CRI (90min., 96 avg.)

Low Output (LO)	2700K 3000K 3500K 4000K			
	Efficacy - Lumens per Watt	42	43	44
Lumens per foot (305mm)	348	359	366	370
Watts per foot (305mm)	8.5	8.5	8.5	8.5

Standard Output (SO)	2700K 3000K 3500K 4000K			
	Efficacy - Lumens per Watt	40	41	42
Lumens per foot (305mm)	521	538	549	554
Watts per foot (305mm)	13.3	13.3	13.3	13.3

Performance | Zipper Board Optics

Zipper Board Optics design has 72 diodes per foot (305mm).

Micro 3508, 120° Symmetric, white finish (S3-WH)

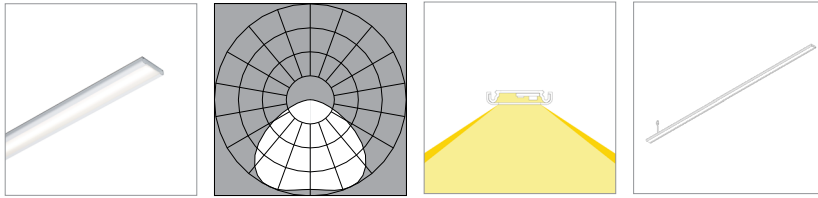

L80 >60,000 hours

90 CRI (90min., 96 avg.)

Low Output (LO)	2700K	3000K	3500K	4000K
Efficacy - Lumens per Watt	99	103	105	106
Lumens per foot (305mm)	368	380	388	391
Watts per foot (305mm)	3.8	3.8	3.8	3.8

Standard Output (SO)	2700K	3000K	3500K	4000K
Efficacy - Lumens per Watt	113	117	119	121
Lumens per foot (305mm)	736	760	775	783
Watts per foot (305mm)	6.6	6.6	6.6	6.6

High Output (HO)	2700K	3000K	3500K	4000K
Efficacy - Lumens per Watt	112	116	118	119
Lumens per foot (305mm)	1105	1139	1163	1174
Watts per foot (305mm)	9.9	9.9	9.9	9.9

Micro 3508, 85° Asymmetric, white finish (A1-WH)

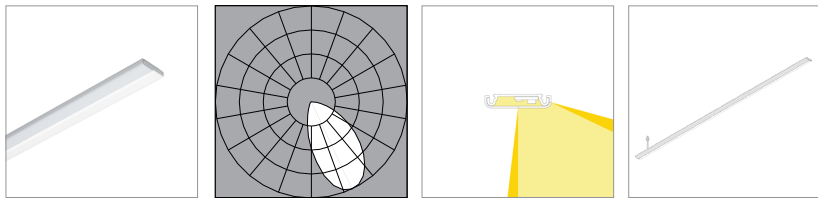

L80 >60,000 hours

90 CRI (90min., 96 avg.)

Low Output (LO)	2700K	3000K	3500K	4000K
Efficacy - Lumens per Watt	55	57	58	58
Lumens per foot (305mm)	203	209	214	216
Watts per foot (305mm)	3.8	3.8	3.8	3.8

Standard Output (SO)	2700K	3000K	3500K	4000K
Efficacy - Lumens per Watt	63	65	66	67
Lumens per foot (305mm)	406	419	427	432
Watts per foot (305mm)	6.5	6.5	6.5	6.5

High Output (HO)	2700K	3000K	3500K	4000K
Efficacy - Lumens per Watt	62	64	65	66
Lumens per foot (305mm)	609	628	641	648
Watts per foot (305mm)	9.9	9.9	9.9	9.9

Performance | Zipper Board Optics | RGBW

Zipper Board Optics design has 72 diodes per foot (305mm).
 RGBW (red, green, blue, and white) tested with **all channels on**.

Micro 3508, 120° Symmetric, white finish (S3-WH)

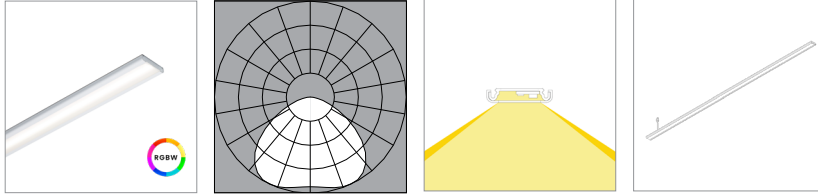

L80 >60,000 hours

	RGBW Color, 90 CRI (90min., 96 avg.)			
	2700K	3000K	3500K	4000K
Low Output (LO)				
Efficacy - Lumens per Watt	60	62	63	64
Lumens per foot (305mm)	500	516	526	532
Watts per foot (305mm)	8.5	8.5	8.5	8.5

	RGBW Color, 90 CRI (90min., 96 avg.)			
	2700K	3000K	3500K	4000K
Standard Output (SO)				
Efficacy - Lumens per Watt	57	59	60	61
Lumens per foot (305mm)	750	774	790	798
Watts per foot (305mm)	13.3	13.3	13.3	13.3

Micro 3508, 85° Asymmetric, white finish (A1-WH)

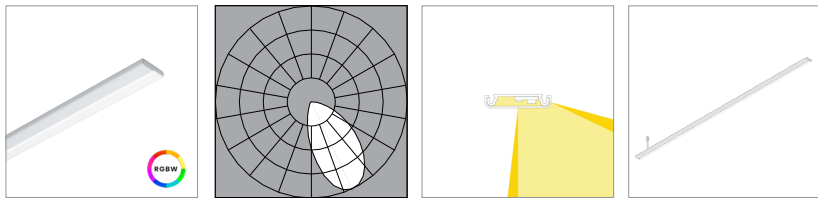

L80 >60,000 hours

	RGBW Color, 90 CRI (90min., 96 avg.)			
	2700K	3000K	3500K	4000K
Low Output (LO)				
Efficacy - Lumens per Watt	30	30	31	31
Lumens per foot (305mm)	91	94	96	97
Watts per foot (305mm)	3.2	3.2	3.2	3.2

	RGBW Color, 90 CRI (90min., 96 avg.)			
	2700K	3000K	3500K	4000K
Standard Output (SO)				
Efficacy - Lumens per Watt	25	25	26	26
Lumens per foot (305mm)	183	189	192	194
Watts per foot (305mm)	7.6	7.6	7.6	7.6

Performance | Zipper Board Optics

Zipper Board Optics design has 72 diodes per foot (305mm).

Micro 3508, High Lumen, white finish (D3-WH)

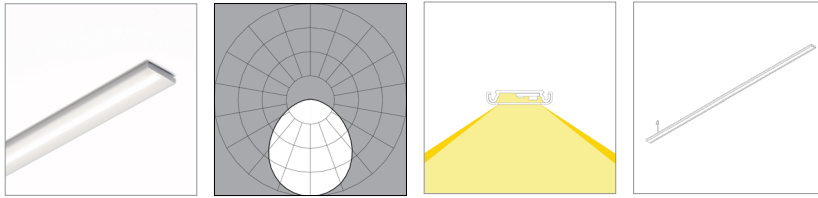

L80 >60,000 hours

90 CRI (90min., 96 avg.)

Low Output (LO)	2700K	3000K	3500K	4000K
Efficacy - Lumens per Watt	112	115	118	119
Lumens per foot (305mm)	415	428	437	441
Watts per foot (305mm)	3.8	3.8	3.8	3.8

Standard Output (SO)	2700K	3000K	3500K	4000K
Efficacy - Lumens per Watt	127	131	134	135
Lumens per foot (305mm)	829	856	873	882
Watts per foot (305mm)	6.6	6.6	6.6	6.6

High Output (HO)	2700K	3000K	3500K	4000K
Efficacy - Lumens per Watt	126	130	133	134
Lumens per foot (305mm)	1244	1284	1310	1323
Watts per foot (305mm)	9.9	9.9	9.9	9.9

Micro 3508, High Lumen with MicroBaffle, white finish (D4-WH)

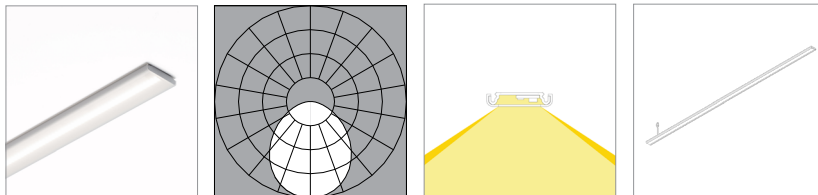

L80 >60,000 hours

90 CRI (90min., 96 avg.)

Low Output (LO)	2700K	3000K	3500K	4000K
Efficacy - Lumens per Watt	100	103	105	106
Lumens per foot (305mm)	369	381	389	393
Watts per foot (305mm)	3.8	3.8	3.8	3.8

Standard Output (SO)	2700K	3000K	3500K	4000K
Efficacy - Lumens per Watt	114	117	120	121
Lumens per foot (305mm)	739	762	777	785
Watts per foot (305mm)	6.6	6.6	6.6	6.6

High Output (HO)	2700K	3000K	3500K	4000K
Efficacy - Lumens per Watt	113	116	118	120
Lumens per foot (305mm)	1108	1143	1166	1178
Watts per foot (305mm)	9.9	9.9	9.9	9.9

Performance | Zipper Board Optics | RGBW

Zipper Board Optics design has 72 diodes per foot (305mm).
 RGBW (red, green, blue, and white) tested with **all channels on**.

Micro 3508, High Lumen, white finish (D3-WH)

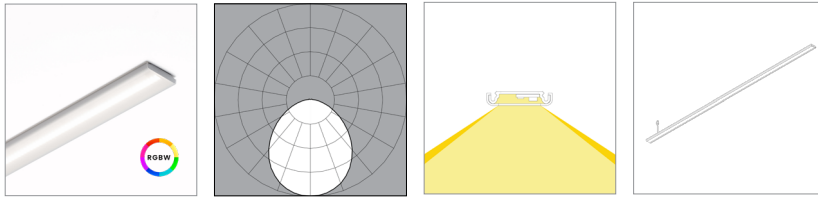

L80 >60,000 hours

	RGBW Color, 90 CRI (90min., 96 avg.)			
	2700K	3000K	3500K	4000K
Low Output (LO)				
Efficacy - Lumens per Watt	42	43	44	44
Lumens per foot (305mm)	346	357	364	367
Watts per foot (305mm)	8.5	8.5	8.5	8.5

	RGBW Color, 90 CRI (90min., 96 avg.)			
	2700K	3000K	3500K	4000K
Standard Output (SO)				
Efficacy - Lumens per Watt	40	41	42	42
Lumens per foot (305mm)	518	535	546	551
Watts per foot (305mm)	13.3	13.3	13.3	13.3

Micro 3508, High Lumen with MicroBaffle, white finish (D4-WH)

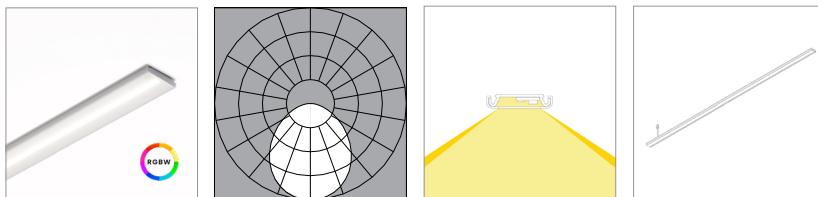

L80 >60,000 hours

	RGBW Color, 90 CRI (90min., 96 avg.)			
	2700K	3000K	3500K	4000K
Low Output (LO)				
Efficacy - Lumens per Watt	41	43	43	44
Lumens per foot (305mm)	129	133	135	137
Watts per foot (305mm)	3.2	3.2	3.2	3.2

	RGBW Color, 90 CRI (90min., 96 avg.)			
	2700K	3000K	3500K	4000K
Standard Output (SO)				
Efficacy - Lumens per Watt	34	36	36	37
Lumens per foot (305mm)	257	265	271	274
Watts per foot (305mm)	7.6	7.6	7.6	7.6

Performance | Zipper Board Optics

Zipper Board Optics design has 72 diodes per foot (305mm).

Micro 3508, 40° Symmetric, black finish (S1-BL)

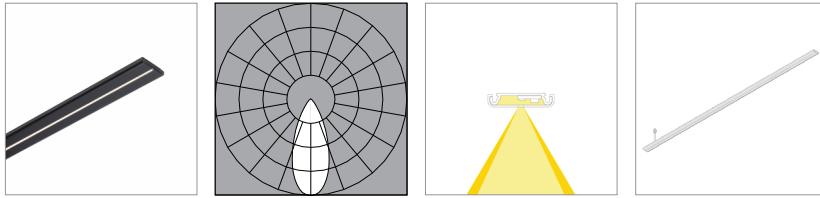

L80 >60,000 hours

90 CRI (90min., 96 avg.)

Low Output (LO)	2700K	3000K	3500K	4000K
Efficacy - Lumens per Watt	33	34	34	35
Lumens per foot (305mm)	120	123	126	127
Watts per foot (305mm)	3.8	3.8	3.8	3.8

Standard Output (SO)	2700K	3000K	3500K	4000K
Efficacy - Lumens per Watt	37	38	39	39
Lumens per foot (305mm)	239	247	252	254
Watts per foot (305mm)	6.6	6.6	6.6	6.6

High Output (HO)	2700K	3000K	3500K	4000K
Efficacy - Lumens per Watt	37	38	39	39
Lumens per foot (305mm)	359	370	378	382
Watts per foot (305mm)	9.9	9.9	9.9	9.9

Micro 3508, 60° Symmetric, black finish (S2-BL)

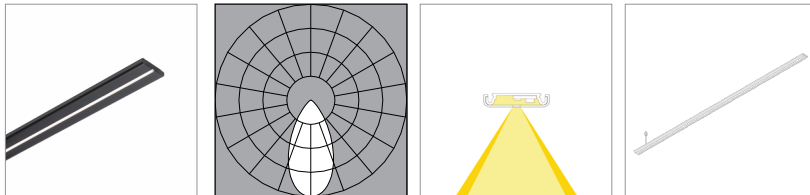

L80 >60,000 hours

90 CRI (90min., 96 avg.)

Low Output (LO)	2700K	3000K	3500K	4000K
Efficacy - Lumens per Watt	46	48	49	49
Lumens per foot (305mm)	171	176	180	181
Watts per foot (305mm)	3.8	3.8	3.8	3.8

Standard Output (SO)	2700K	3000K	3500K	4000K
Efficacy - Lumens per Watt	53	55	56	56
Lumens per foot (305mm)	341	352	359	363
Watts per foot (305mm)	6.5	6.5	6.5	6.5

High Output (HO)	2700K	3000K	3500K	4000K
Efficacy - Lumens per Watt	52	54	55	56
Lumens per foot (305mm)	512	528	539	544
Watts per foot (305mm)	9.9	9.9	9.9	9.9

Performance | Zipper Board Optics | RGBW

Zipper Board Optics design has 72 diodes per foot (305mm).
 RGBW (red, green, blue, and white) tested with **all channels on**.

Micro 3508, 40° Symmetric, black finish (S1-BL)

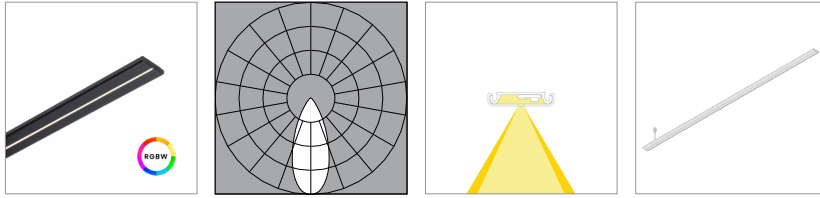

L80 >60,000 hours

	RGBW Color, 90 CRI (90min., 96 avg.)			
	2700K	3000K	3500K	4000K
Low Output (LO)				
Efficacy - Lumens per Watt	20	20	21	21
Lumens per foot (305mm)	162	168	171	173
Watts per foot (305mm)	8.5	8.5	8.5	8.5

	RGBW Color, 90 CRI (90min., 96 avg.)			
	2700K	3000K	3500K	4000K
Standard Output (SO)				
Efficacy - Lumens per Watt	19	19	20	20
Lumens per foot (305mm)	244	251	257	259
Watts per foot (305mm)	13.3	13.3	13.3	13.3

Micro 3508, 60° Symmetric, black finish (S2-BL)

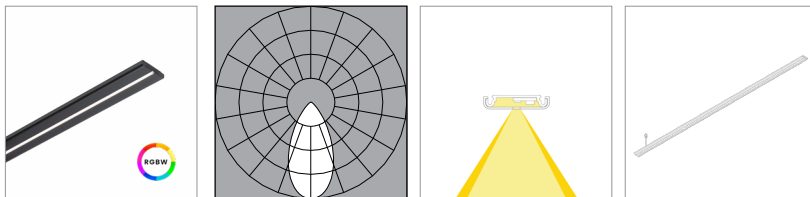

L80 >60,000 hours

	RGBW Color, 90 CRI (90min., 96 avg.)			
	2700K	3000K	3500K	4000K
Low Output (LO)				
Efficacy - Lumens per Watt	28	29	29	30
Lumens per foot (305mm)	232	239	244	246
Watts per foot (305mm)	8.5	8.5	8.5	8.5

	RGBW Color, 90 CRI (90min., 96 avg.)			
	2700K	3000K	3500K	4000K
Standard Output (SO)				
Efficacy - Lumens per Watt	27	28	28	28
Lumens per foot (305mm)	348	359	366	370
Watts per foot (305mm)	13.3	13.3	13.3	13.3

Performance | Zipper Board Optics

Zipper Board Optics design has 72 diodes per foot (305mm).

Micro 3508, 120° Symmetric, black finish (S3-BL)

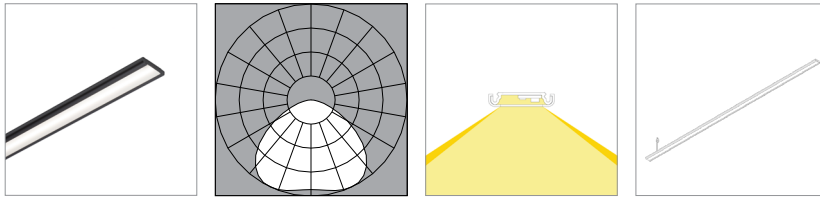

L80 >60,000 hours

90 CRI (90min., 96 avg.)

Low Output (LO)	2700K	3000K	3500K	4000K
Efficacy - Lumens per Watt	88	91	93	94
Lumens per foot (305mm)	357	369	376	380
Watts per foot (305mm)	4.1	4.1	4.1	4.1

Standard Output (SO)	2700K	3000K	3500K	4000K
Efficacy - Lumens per Watt	110	113	116	117
Lumens per foot (305mm)	715	737	752	760
Watts per foot (305mm)	6.6	6.6	6.6	6.6

High Output (HO)	2700K	3000K	3500K	4000K
Efficacy - Lumens per Watt	109	112	115	116
Lumens per foot (305mm)	1072	1106	1128	1140
Watts per foot (305mm)	9.9	9.9	9.9	9.9

Micro 3508, 85° Asymmetric, black finish (A1-BL)

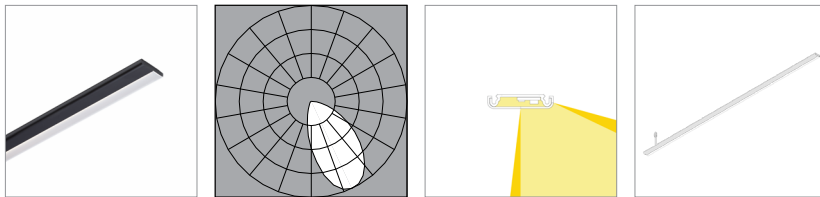

L80 >60,000 hours

90 CRI (90min., 96 avg.)

Low Output (LO)	2700K	3000K	3500K	4000K
Efficacy - Lumens per Watt	31	32	32	33
Lumens per foot (305mm)	113	116	119	120
Watts per foot (305mm)	3.8	3.8	3.8	3.8

Standard Output (SO)	2700K	3000K	3500K	4000K
Efficacy - Lumens per Watt	35	36	37	37
Lumens per foot (305mm)	226	233	238	240
Watts per foot (305mm)	6.6	6.6	6.6	6.6

High Output (HO)	2700K	3000K	3500K	4000K
Efficacy - Lumens per Watt	35	36	37	37
Lumens per foot (305mm)	339	349	357	360
Watts per foot (305mm)	9.9	9.9	9.9	9.9

Performance | Zipper Board Optics | RGBW

Zipper Board Optics design has 72 diodes per foot (305mm).
 RGBW (red, green, blue, and white) tested with **all channels on**.

Micro 3508, 120° Symmetric, black finish (S3-BL)

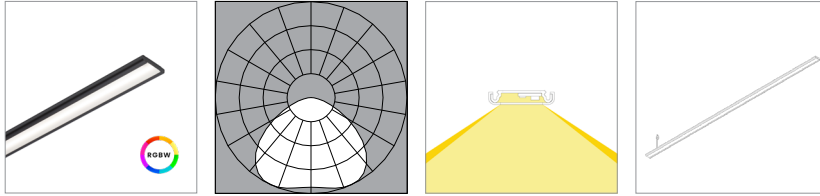

L80 >60,000 hours

RGBW Color, 90 CRI (90min., 96 avg.)

Low Output (LO)	2700K	3000K	3500K	4000K
Efficacy - Lumens per Watt	58	60	61	62
Lumens per foot (305mm)	485	501	511	516
Watts per foot (305mm)	8.5	8.5	8.5	8.5

Standard Output (SO)	2700K	3000K	3500K	4000K
Efficacy - Lumens per Watt	55	57	58	59
Lumens per foot (305mm)	728	751	766	774
Watts per foot (305mm)	13.3	13.3	13.3	13.3

Micro 3508, 85° Asymmetric, black finish (A1-BL)

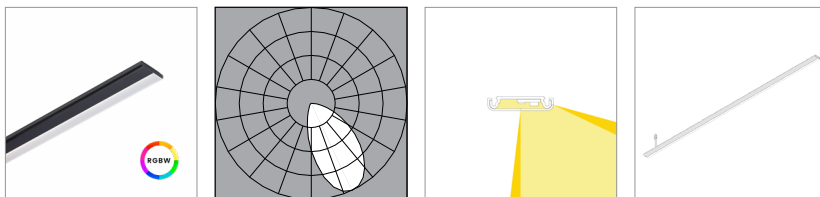

L80 >60,000 hours

RGBW Color, 90 CRI (90min., 96 avg.)

Low Output (LO)	2700K	3000K	3500K	4000K
Efficacy - Lumens per Watt	19	19	20	20
Lumens per foot (305mm)	153	158	161	163
Watts per foot (305mm)	8.5	8.5	8.5	8.5

Standard Output (SO)	2700K	3000K	3500K	4000K
Efficacy - Lumens per Watt	18	18	19	19
Lumens per foot (305mm)	230	237	242	245
Watts per foot (305mm)	13.3	13.3	13.3	13.3

Copyright © 2025 Vode Lighting LLC. All rights reserved. Vode, the Vode logo, BoxRail, FlyWing, MicroBaffle, Button Board, Zipper Board, Zero Canopy, Zero Block, VodeNODE and other names are either registered trademarks or trademarks of Vode Lighting LLC in the United States and may be registered in other countries. All other trademarks listed herein belong to their respective owners. Due to ongoing innovation, specification details may change without notice.