



Spec Guide

# ZipTwo | Square 3555 | Ceiling Cable | 707



Direct lighting for open office and ambient applications.



Square 3555, Diffuse, white

### Benefits & Features

#### Minimal Profile, Robust Design

Square profile. 1.38" (35mm) x 2.13" (54mm).

#### Superior Light Quality & Performance

Output up to 1538 lm/ft (5044 lm/m) (HO), 156 lm/W HO. 90 CRI & tunable white (2200K-5000K) available.

#### Adaptive Power

Full range dimming power for all protocols. Integral or remote power available. Remote power available up to 100' (30.5m) away.

#### Extensive Optics

Options of Diffuse, Critical Edge, and Side Diffuse give designers the power to create and design their space using one product.

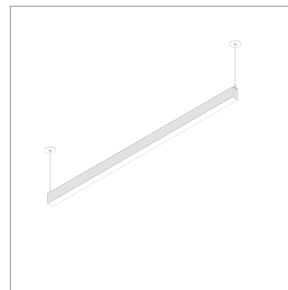

Small Round Canopy

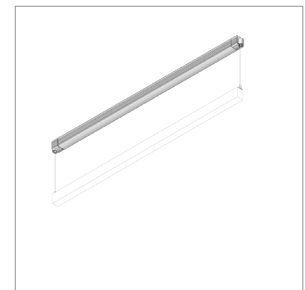

Integral Power

Build Your Specification

707-Z2	S			CC	»
--------	---	--	--	----	---

System & Rail Type	System Type	System Length	Rail Length	Mounting	Arm/Cord Length
707-Z2 ZipTwo	S Suspended	Specify overall system length in ft/in or M/mm.  <i>Corner and Shapes Available See Guide for details.</i>	<b>24</b> 24" (610mm) <b>36</b> 36" (914mm) <b>48</b> 48" (1219mm) <b>60</b> 60" (1524mm) <b>72</b> 72" (1829mm) <b>96</b> 96" (2438mm) <b>108</b> 108" (2743 mm) <b>120</b> 120" (3048 mm) <b>132</b> 132" (3352 mm) <b>144</b> 144" (3658 mm) <b>ZZ</b> Other rail length or layout (please specify)	CC Ceiling Cable	<b>48</b> 48" cord (1219mm) <b>96</b> 96" cord (2438mm) <b>ZZ</b> Other (please specify)

See [Rail Length Chart](#) for more details.

**⚠ Custom lengths may result in light gaps on the fixture. See [Rail Length Chart](#) for more details.**

»				»
---	--	--	--	---

Power Location	Power Type	Voltage	Emergency Power
<b>Integral Power</b> IP Integral Power <b>Remote Power</b> Specify mounting and harness length code example: <b>2R25, 2R50</b> ...etc. <b>Mounting Option</b> <b>2R</b> Small Round Canopy <b>4R</b> Large Round Canopy <b>Wire Harness</b> <b>10</b> 10' (3.048m) Wire Harness <b>25</b> 25' (7.62m) Wire Harness <b>50</b> 50' (15.24m) Wire Harness <b>75</b> 75' (22.86m) Wire Harness <b>100</b> 100' (30.48m) Wire Harness	<b>Flexible 1 to 1 Power</b> <b>AE</b> 0-10v, 1.0% Dimming <b>AT</b> 0-10v, 0.1% Dimming <b>AD</b> DALI, 0.1% Dimming <b>AX</b> DMX, 100-0% Dimming <b>AH</b> Hi-lume 1% EcoSystem, Soft On / Fade to Black Technology, LDE1 <b>AH2</b> ELV 1% 2-wire (Forward and Reverse Phase)  <b>Optimized Power</b> Add 'O' to power type example: AEO, ATO...etc. <sup>1</sup> <b>VodeNODE</b> Add 'N' to power type for Flexible 1 to 1 Power Add 'ON' to power type for Optimized Power example: AEN, ATN, AEON, ADON...etc. <sup>2</sup> <b>ZZ</b> Other (please specify) See <a href="#">Power Guide</a> for driver features & limitations.	<b>1</b> 120V <b>2</b> 120V - 277V <b>X</b> Not Yet Specified	<b>0</b> No Emergency Power <b>ZZ</b> Emergency Power (specify requirements)

»	Z				»
---	---	--	--	--	---

LED Type	Lumen Output	90+ CRI	Optics	Sensors <sup>4</sup>
Z Zipper Board	<b>LO</b> Low Output <b>SO</b> Standard Output <b>HO</b> High Output <b>ZZ</b> Other (please specify)  See <a href="#">IES Files</a> page for details. See <a href="#">Power Guide</a> for driver features & limitations.	<b>27</b> 2700K <b>30</b> 3000K <b>35</b> 3500K <b>40</b> 4000K  <b>ZZ</b> Tunable White Available See <a href="#">Guide</a> for details	<b>J6</b> Square 3555, Diffuse <sup>3</sup> <b>J9</b> Square 3555, Side Diffuse <b>JA</b> Square 3555, Single Side Diffuse	<b>0</b> None <b>ENC</b> Canopy with integrated Enlighted Micro Sensor <b>WSC</b> Canopy with integrated Legrand Wattstopper sensor <b>LAC</b> Canopy with integrated Lutron Athena sensor <b>ZZ</b> Other (please specify)

»	
---	--

Finish	Options
WH White	<b>0</b> None
BL Black	<b>9</b> 9' 18/3 Cord and Plug
	<b>LLLC</b> Luminaire Level Lighting Controls
	<b>CPS</b> Chicago Plenum Fixture Adapter & Power
	<b>CPP</b> Chicago Plenum Power
	<b>CPA</b> Chicago Plenum Fixture Adapter

**NOTES & LIMITATIONS**

<sup>1</sup> Optimized Power is not available with Hi-lume 1% EcoSystem (AHO) Power Type.

<sup>2</sup> VodeNODE enclosure is not available with ELV 1% 2-wire (AH2) Power Type.

<sup>3</sup> Square 3555, Diffuse is only available in White Finish (WH).

<sup>4</sup> Sensors, drivers and control units that are integrated into Vode fixtures are discrete components that communicate with network lighting controls. For more information about each network lighting control system, visit the manufacturer's website for additional system information and technical data sheets.

For general information about network lighting controls, consult the DesignLights Consortium® (DLC) [Networked Lighting Control Qualified Product List](#)

Listed to UL standards for damp location by a Nationally Recognized Testing Laboratory (NRTL) recognized by OSHA. Certain limitations exist for each Certification. Contact factory for verification.

Standard 5 Year Limited Warranty. See details [here](#). Contact factory for options on Limited Warranties up to 20 years.



## Applications

### General Interior and Open Office



Square 3555, Critical Edge



Square 3555, Critical Edge



Square 3555, Critical Edge

## Sustainability & Certifications

### DECLARE

#### International Living Future Institute (ILFI)

Red List Approved

All Vode Lighting linear light fixtures proudly carry the Red List Approved designation.



# Declare.

#### Vode Adaptive Architectural Lighting Systems Vode Lighting LLC

**Final Assembly:** Sonoma, California, US  
**Life Expectancy:** 10+ Year(s)  
**End of Life Options:** Recyclable (100%)

#### Ingredients:

Steel; Anodized Aluminum (6063-T5 Alloy); Small Electrical Component (RoHS); Copper; **Fluorinated Ethylene Propylene (masterbatch)**; Polymethyl methacrylate (PMMA); Stainless Steel; Polyoxymethylene Copolymer (POM); Styrene-butadiene polymer, hydrogenated; Poly(methyl methacrylate/butyl acrylate/styrene) (PMMA/BA/S); Styrene/butadiene copolymer; Distillates; Polypropylene; Calcium carbonate; Polycarbonate; EVA Copolymer; Methyl methacrylate (MMA); Polyphenylene Oxide; Brass; Tin, Organic

**Living Building Challenge Criteria:** Compliant

#### I-13 Red List:

- LBC Red List Free      % Disclosed: 100% at 100ppm
- LBC Red List Approved      VOC Content: Not Applicable
- Declared

**I-10 Interior Performance:** Not Applicable

**I-14 Responsible Sourcing:** Not Applicable

VDE-0001  
EXP. 01 FEB 2026  
Original Issue Date: 2018

MANUFACTURER RESPONSIBLE FOR LABEL ACCURACY  
INTERNATIONAL LIVING FUTURE INSTITUTE™ [living-future.org/declare](http://living-future.org/declare)

Click here to learn more: [International Living Future Institute](http://International Living Future Institute)

### TM65NA

#### CIBSE & ASHRAE on Embodied Carbon

Vode recognizes TM65NA as the highest standard for understanding the embodied carbon of our fixtures.

Developed with ASHRAE, it adapts CIBSE's TM65 for North America, ensuring accurate regional assessments. It must be used alongside TM65 and follows TM65LA's framework.

**System:** 707 | ZipTwo | Ceiling Cable  
**Embodied Carbon (kg CO<sub>2</sub>e):** 36.89\*

\***Note:** Embodied Carbon, expressed in kilograms of CO<sub>2</sub>e is calculated using a 48" fixture and includes the LED driver.



Click here to learn more [CIBSE](#), [ASHRAE](#).

### BAA X BABA

#### Buy American Act / Build America & Buy America Act Compliance

Vode is dedicated to supporting domestic manufacturing and ensuring compliance with BAA and BABA requirements.

Given the complexity of our products, we recommend reaching out to [vodecares@vode.com](mailto:vodecares@vode.com) for confirmation regarding compliance for your specific project.



Click here to learn more: [US Department of Commerce](http://US Department of Commerce)

## Structure

Rail Lengths	24" (610mm) - 144" (3658mm). Modified lengths available. See <a href="#">Rail Length Chart</a> for more details.
Rail Dimensions	1.38" (35mm) x 2.82" (72mm) x length.
Construction	Extruded and machined 6063 aluminum.
Mounting	Ceiling mount to jbox or driver housing.
Cable Length	48" (1220mm) and 96" (2438mm) available. Field adjustable. Non-standard cable lengths available.
System Run Length	24" (610mm) minimum. Unlimited maximum.
Operating Temperature	32°F to 104°F (0°C to 40°C).
Humidity	0-85%, non-condensing.
System Weight	0.44 lbs per foot (0.20 kg per 305mm) Power supply and housing not included.

## Materials

LED Board Construction	Aluminum core PCB, black LCP connectors, RoHS compliant.
Lens	High-impact extruded acrylic glass (PMMA).
Suspension Cable	Ø4mm, 22/4 AWG, TPE jacket, FEP-insulated, Red List Approved.
Power Cable	Ø3mm, 33/2 AWG, Plenum (CMP) rated semi-rigid PVC or FEP, flame tested UL-910, Red List Approved.
Cable Connectors	Unfilled black nylon, rated UL 94 V-0, halogen free, PVC or FEP overmold, RoHS compliant, Red List Approved.
Remote Linear Power Housing	20.7" x 2.375" x 2.53", 0.054" formed Galvanized Steel.
Remote Brick Power Housing	4.32" x 3.37" x .078" Galvanized Steel mounting plate.
Integral Power Housing	extruded and machined 6063 aluminum.
Center Cable Suspension	3/64" aircraft cable.

## Mounting Options

### Remote Power

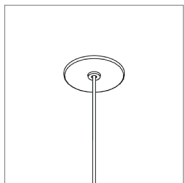

Small Round Canopy  
Ø2.5" (51mm)

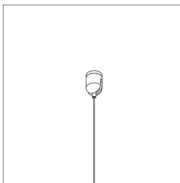

Center Support Cable  
108" - 144" Rails Only  
Center Support Cable for mounting to T-Bar tile available.

### Integral Power (24"-72")

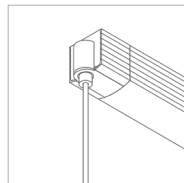

Integral Power (end)  
h 1.8" (46mm)  
w 1.7" (43mm)

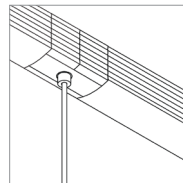

Integral Power (joint)

## Dimensions

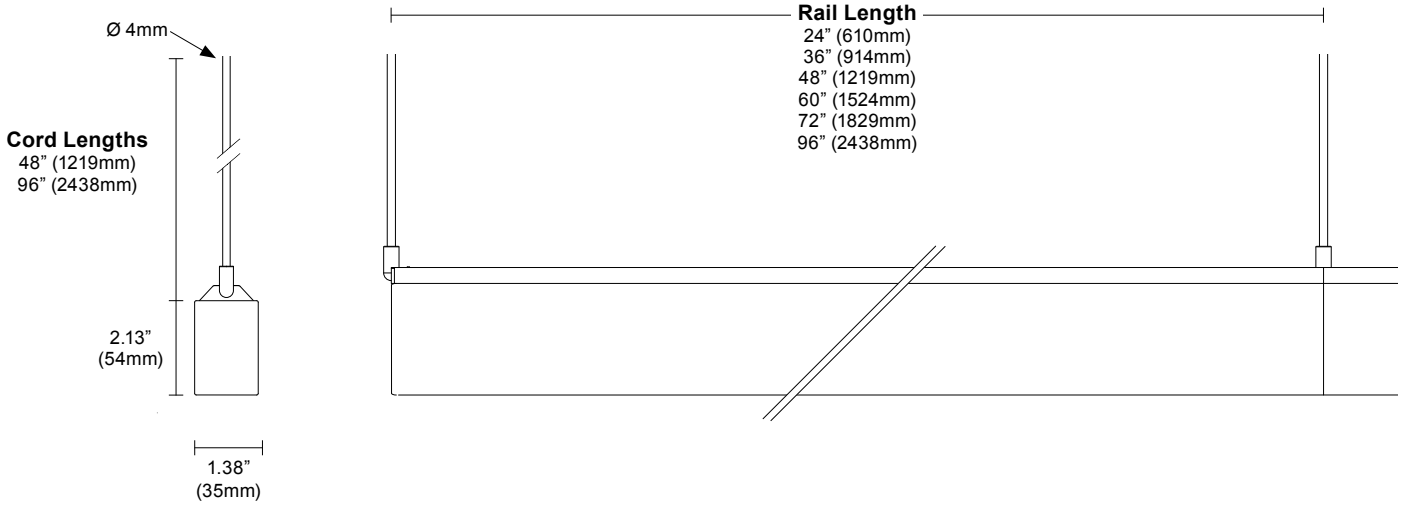

## Layout

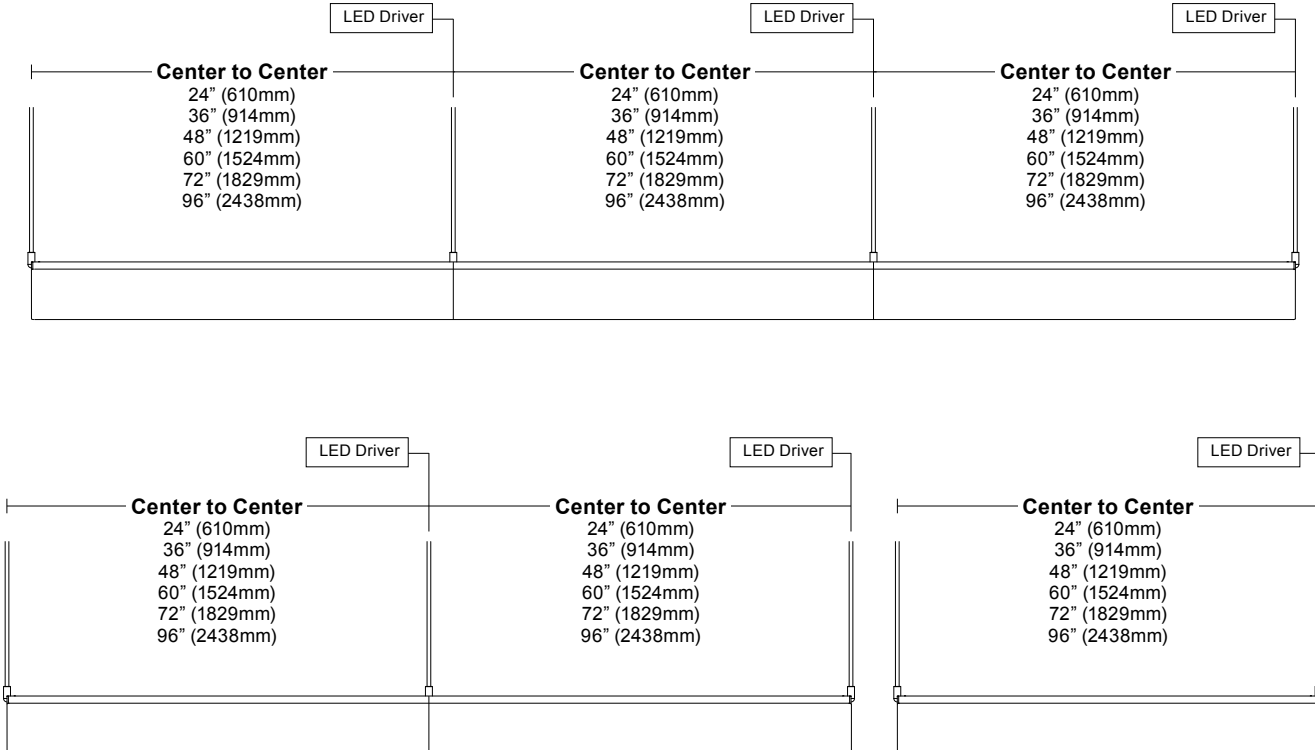

Corner and Shapes Available (Square, Rectangle, L-Shape, U-Shape, ZigZag) [See Guide](#) for details.

## Rail Dimensions

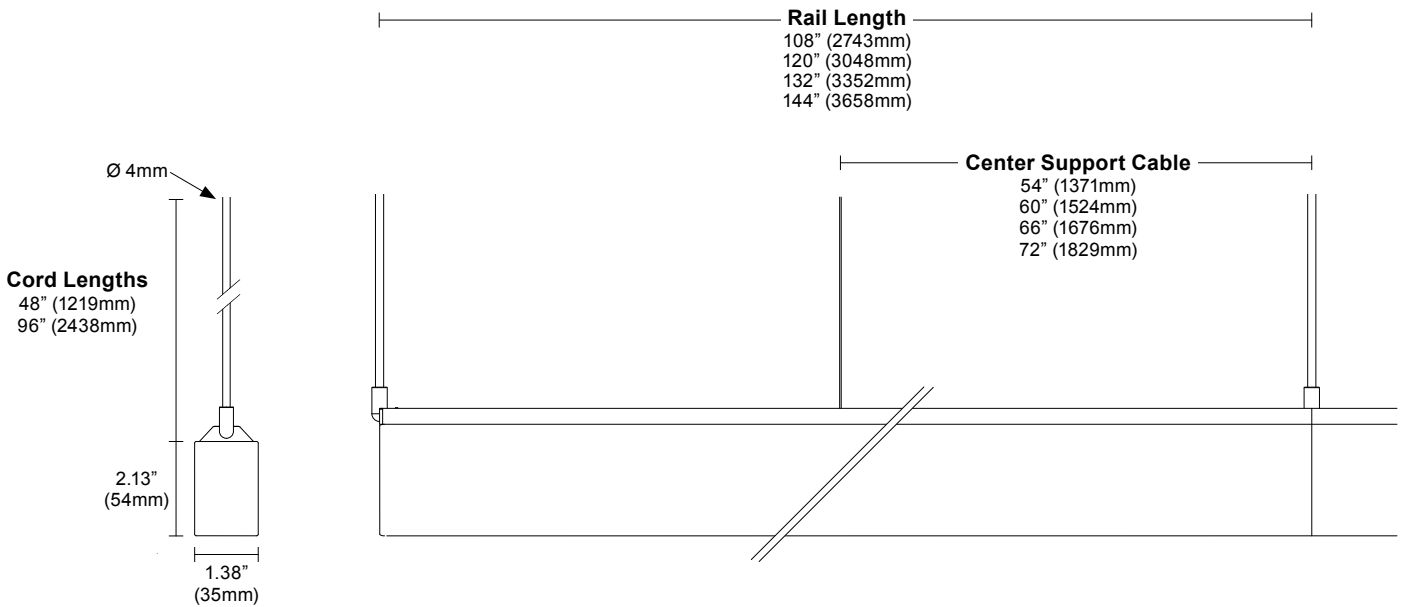

## Layout

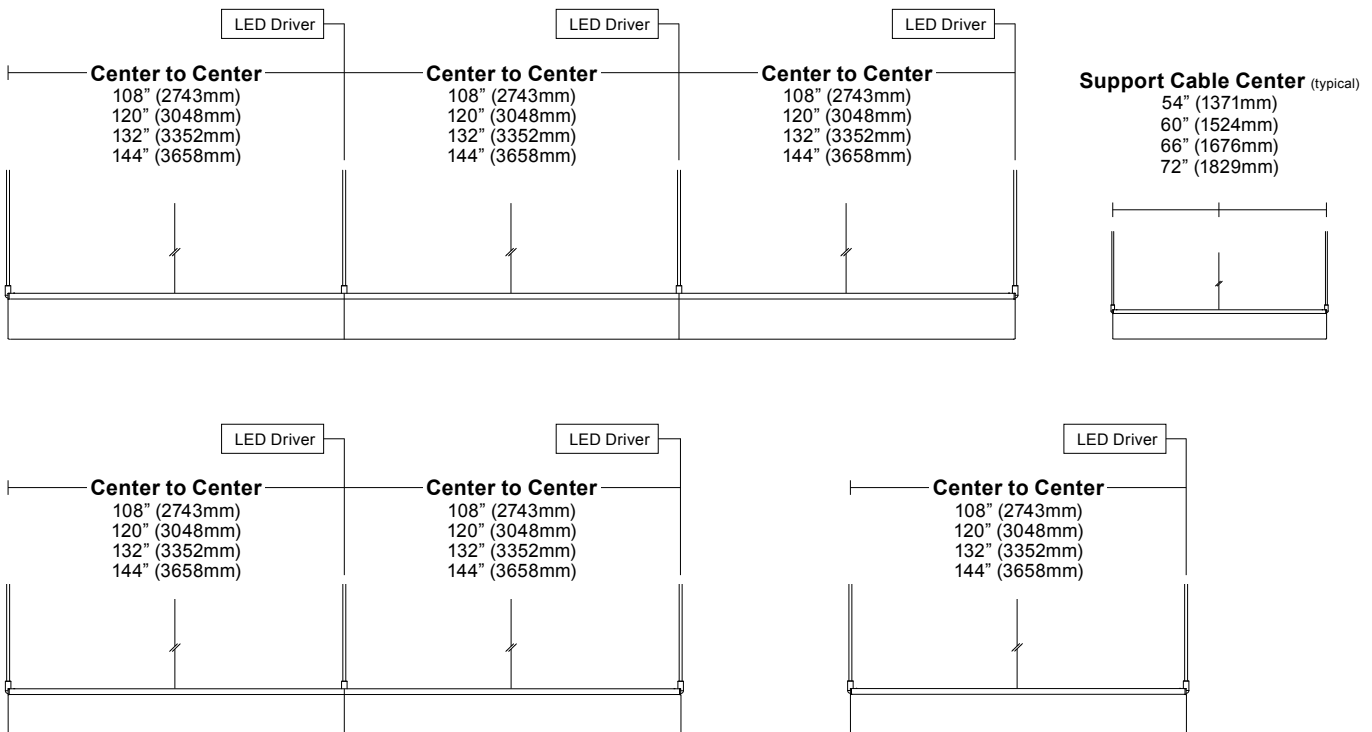

Corner and Shapes Available (Square, Rectangle, L-Shape, U-Shape, ZigZag) [See Guide](#) for details.

## vodeCONNECT Sensors

Canopy with integrated sensor

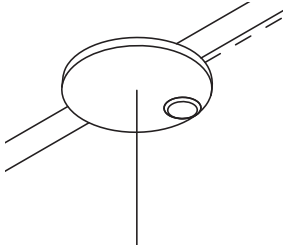

Sensor partners



### Integrated canopy sensor layout <sup>1</sup>

*1 sensor per fixture. See [vodeCONNECT brochure](#) for more details.*

**NOTES:** 1. Available with Large Round Canopy only.

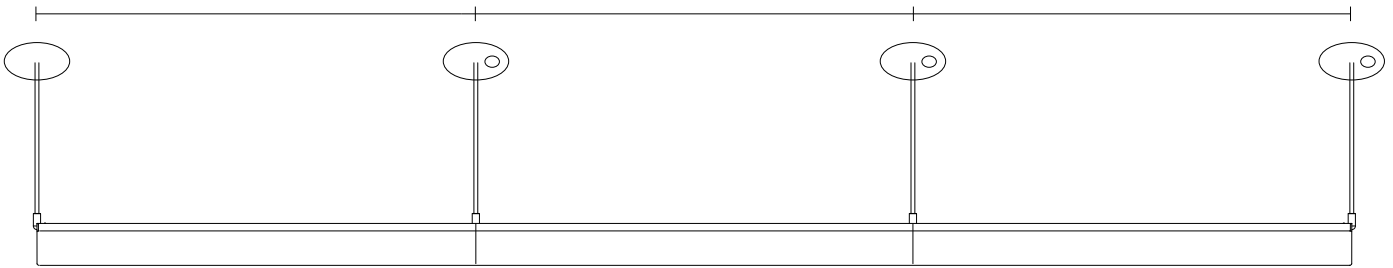

### Compatible sensors



Lutron Athena



Legrand Wattstopper



Enlighted Micro Sensor



## Power and Controls

Power Type	Class 2 (<60V output) constant current driver.
Dimming Controls	Dimming (0.1%, 1%), 0-10V, DALI, DMX, Hi-lume 1% are available. See <a href="#">Power Guide</a> for details.
Input Voltage	120V - 277V, 50/60hz.
Power Location	Remote power. Maximum remote distance up to 100' (30.5m) depending on driver selection. See <a href="#">Power Guide</a> for details.

Remote power is locating the power supply away from the fixture. Remote power comes in two housing styles: brick style and linear style. Consult [Power Guide](#) to determine which type you will receive.

### Remote Brick Power Housing

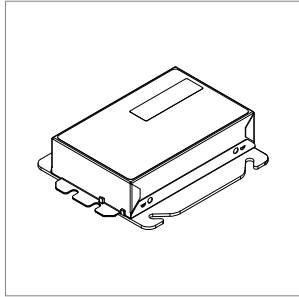

Supplied for some remote power applications. One remote power supply housing is supplied for each rail. Provided driver mounting plate fits standard 4" metal, square J-Boxes with a minimum volume of 21 in<sup>3</sup> (J-Box not provided). See [Tech Sheet](#) for details.

### Remote Linear Power Housing

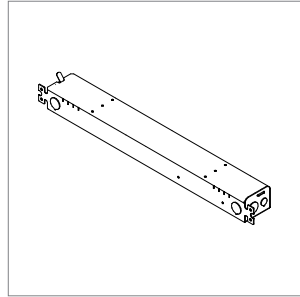

One remote power supply housing is supplied with each power supply. All Vode linear remote drivers come in a 0.054" (0.8mm) formed galvanized steel power supply housing with five (5) knockouts: (4) 1-1/8", (1) 7/8" and (1) 9/16". Accommodates standard linear power supplies. See [Tech Sheet](#) for details.

### Integral Power

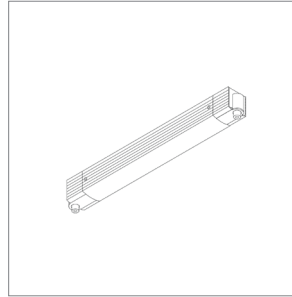

Houses integral power supply. Direct conduit feed is recommended, but integral power supply housing will mount to any standard North America 4" j-box. Mounts to most surfaces. Blocking is recommended at all arm junctions. See [Tech Sheet](#) for details.

### Wire Harness

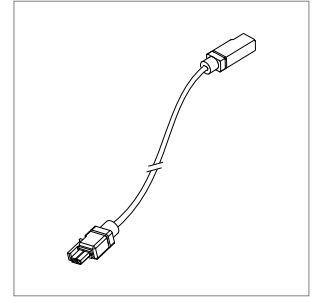

Wire harness connects driver to rail section. Lengths of 10' (3.0m) & 25' (7.6m) with snap-lock connectors for quick and easy installation. Multiple harnesses may be combined for lengths up to 100' (30.5m). See [Tech Sheet](#) for details.

## Power and Controls

### Flexible 1 to 1 power

For Flexible 1 to 1 Power, Vode supplies one single output driver per fixture, allowing each fixture to be controlled independently. Direct/Indirect fixtures are supplied with two single output drivers, allowing the direct and indirect lighting to be controlled independently. Consult [Power Guide](#) to determine which type you will receive.

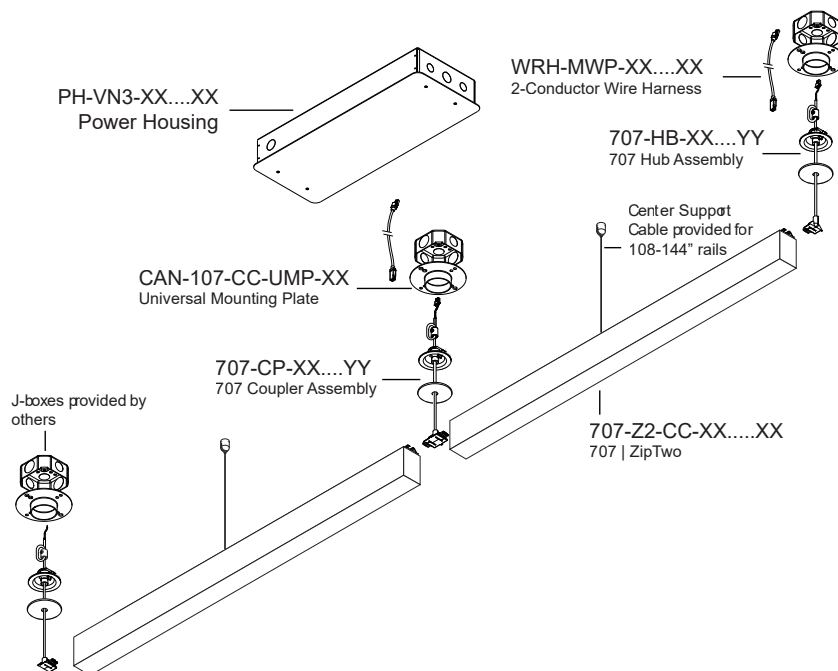

Note: Drawings not to scale, for reference only.

### Optimized Power

To optimize power, Vode configures specifications with drivers that have 2 or 4 outputs. Depending on system configurations and power requirements, up to 4 fixtures can be powered from a 4-output driver. Consult [Power Guide](#) to determine which type you will receive.

IMPORTANT: Each fixture will still require individual wire harnesses, as shown below.

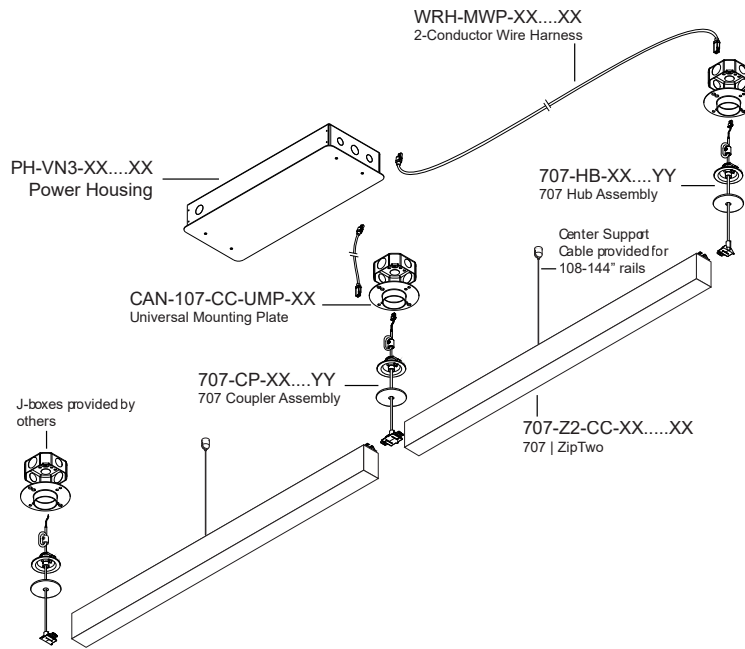

### Finish

White Finish



White Rail, White Canopy/Integral Power, White Cable

Black Finish



Black Rail, Black Canopy/Integral Power, Black Cable

Note: Drawings not to scale, for reference only.

## Performance | Zipper Board Optics

Zipper Board Optics design has 72 diodes per foot (305mm).

### Square 3555, Diffuse, white finish (J6-WH)

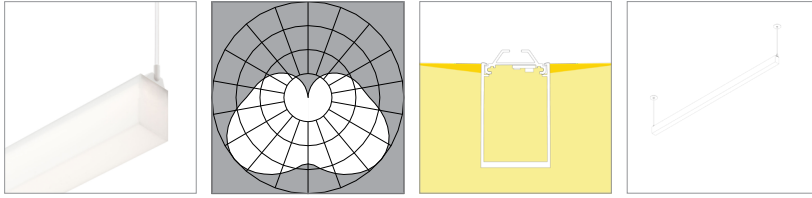

L90 >100,000 hours

**90 CRI (90min., 96 avg.)**

<b>Low Output (LO)</b>	2700K	3000K	3500K	4000K
Efficacy - Lumens per Watt	112	115	118	119
Lumens per foot (305mm)	414	427	436	440
Watts per foot (305mm)	3.8	3.8	3.8	3.8

<b>Standard Output (SO)</b>	2700K	3000K	3500K	4000K
Efficacy - Lumens per Watt	127	131	134	135
Lumens per foot (305mm)	828	854	872	880
Watts per foot (305mm)	6.6	6.6	6.6	6.6

<b>High Output (HO)</b>	2700K	3000K	3500K	4000K
Efficacy - Lumens per Watt	126	130	133	134
Lumens per foot (305mm)	1242	1281	1308	1321
Watts per foot (305mm)	9.9	9.9	9.9	9.9

### Square 3555, Side Diffuse, white finish (J9-WH)

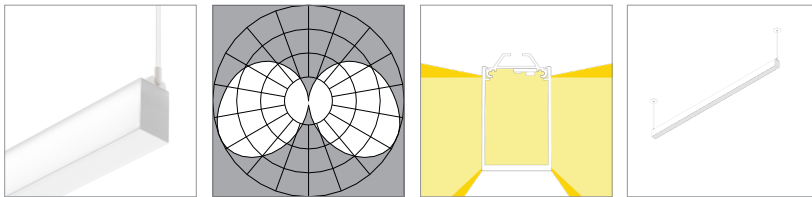

L90 >100,000 hours

**90 CRI (90min., 96 avg.)**

<b>Low Output (LO)</b>	2700K	3000K	3500K	4000K
Efficacy - Lumens per Watt	99	103	105	106
Lumens per foot (305mm)	368	380	387	391
Watts per foot (305mm)	3.8	3.8	3.8	3.8

<b>Standard Output (SO)</b>	2700K	3000K	3500K	4000K
Efficacy - Lumens per Watt	113	117	119	120
Lumens per foot (305mm)	736	759	775	783
Watts per foot (305mm)	6.6	6.6	6.6	6.6

<b>High Output (HO)</b>	2700K	3000K	3500K	4000K
Efficacy - Lumens per Watt	112	116	118	119
Lumens per foot (305mm)	1104	1139	1162	1174
Watts per foot (305mm)	9.9	9.9	9.9	9.9

## Performance | Zipper Board Optics

Zipper Board Optics design has 72 diodes per foot (305mm).

### Square 3555, Single Side Diffuse, white finish (JA-WH)

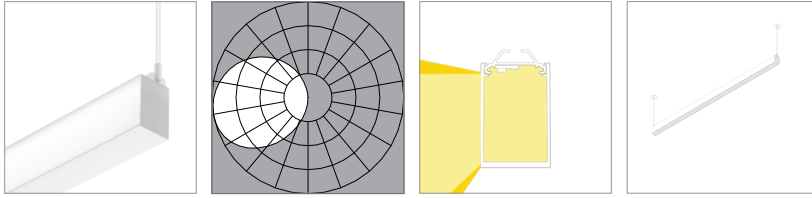

L90 >100,000 hours

**90 CRI (90min., 96 avg.)**

<b>Low Output (LO)</b>	2700K	3000K	3500K	4000K
Efficacy - Lumens per Watt	80	83	85	86
Lumens per foot (305mm)	298	307	313	316
Watts per foot (305mm)	3.8	3.8	3.8	3.8

<b>Standard Output (SO)</b>	2700K	3000K	3500K	4000K
Efficacy - Lumens per Watt	91	94	96	97
Lumens per foot (305mm)	595	614	627	633
Watts per foot (305mm)	6.6	6.6	6.6	6.6

<b>High Output (HO)</b>	2700K	3000K	3500K	4000K
Efficacy - Lumens per Watt	91	94	96	97
Lumens per foot (305mm)	893	921	940	949
Watts per foot (305mm)	9.9	9.9	9.9	9.9

### Square 3555, Side Diffuse, black finish (J9-BL)

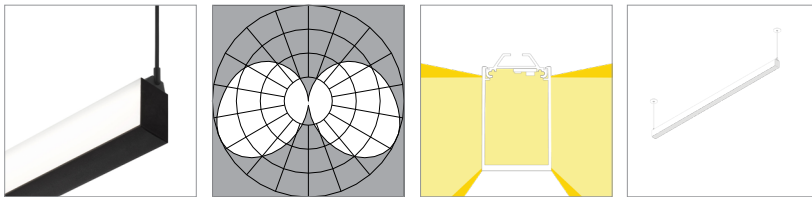

L90 >100,000 hours

**90 CRI (90min., 96 avg.)**

<b>Low Output (LO)</b>	2700K	3000K	3500K	4000K
Efficacy - Lumens per Watt	96	99	101	102
Lumens per foot (305mm)	356	368	375	379
Watts per foot (305mm)	3.8	3.8	3.8	3.8

<b>Standard Output (SO)</b>	2700K	3000K	3500K	4000K
Efficacy - Lumens per Watt	110	113	115	116
Lumens per foot (305mm)	713	735	750	758
Watts per foot (305mm)	6.6	6.6	6.6	6.6

<b>High Output (HO)</b>	2700K	3000K	3500K	4000K
Efficacy - Lumens per Watt	109	112	114	115
Lumens per foot (305mm)	1069	1103	1126	1137
Watts per foot (305mm)	9.9	9.9	9.9	9.9

## Performance | Zipper Board Optics

Zipper Board Optics design has 72 diodes per foot (305mm).

Square 3555, Single Side Diffuse, black finish (JA-BL)

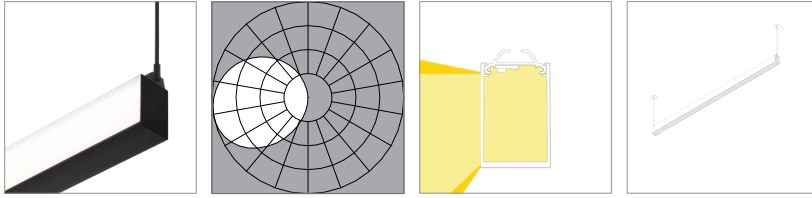

L90 >100,000 hours

**90 CRI (90min., 96 avg.)**

<b>Low Output (LO)</b>	<b>2700K</b>	<b>3000K</b>	<b>3500K</b>	<b>4000K</b>
Efficacy - Lumens per Watt	76	78	80	81
Lumens per foot (305mm)	281	289	295	298
Watts per foot (305mm)	3.8	3.8	3.8	3.8
<b>Standard Output (SO)</b>	<b>2700K</b>	<b>3000K</b>	<b>3500K</b>	<b>4000K</b>
Efficacy - Lumens per Watt	86	89	91	92
Lumens per foot (305mm)	561	579	591	597
Watts per foot (305mm)	6.6	6.6	6.6	6.6
<b>High Output (HO)</b>	<b>2700K</b>	<b>3000K</b>	<b>3500K</b>	<b>4000K</b>
Efficacy - Lumens per Watt	86	88	90	91
Lumens per foot (305mm)	842	868	886	895
Watts per foot (305mm)	9.9	9.9	9.9	9.9

Copyright © 2025 Vode Lighting LLC. All rights reserved. Vode, the Vode logo, BoxRail, FlyWing, MicroBaffle, Button Board, Zipper Board, Zero Canopy, Zero Block, VodeNODE and other names are either registered trademarks or trademarks of Vode Lighting LLC in the United States and may be registered in other countries. All other trademarks listed herein belong to their respective owners. Due to ongoing innovation, specification details may change without notice.