



Spec Guide

ZipTwo | Square 3555 | Ceiling Cable | 707



Direct lighting for open office and ambient applications.



Square 3555, Diffuse, white

Benefits & Features

Minimal Profile, Robust Design

Square profile. 1.38" (35mm) x 2.13" (54mm).

Superior Light Quality & Performance

Output up to 1538 lm/ft (5044 lm/m) (HO), 156 lm/W HO. 90 CRI & tunable white (2200K-5000K) available.

Adaptive Power

Full range dimming power for all protocols. Integral or remote power available. Remote power available up to 100' (30.5m) away.

Extensive Optics

Options of Diffuse, Critical Edge, and Side Diffuse give designers the power to create and design their space using one product.

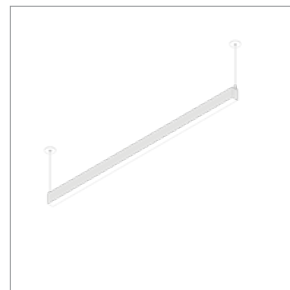

Small Round Canopy



Integral Power

Build Your Specification

707-Z2	S			CC	»
---------------	----------	--	--	-----------	---

System & Rail Type	System Type	System Length	Rail Length	Mounting	Arm/Cord Length
707-Z2 ZipTwo	S Suspended	Specify overall system length in ft/in or M/mm. <i>Corner and Shapes Available See Guide for details.</i>	24 24" (610mm) 36 36" (914mm) 48 48" (1219mm) 60 60" (1524mm) 72 72" (1829mm) 96 96" (2438mm) 108 108" (2743 mm) 120 120" (3048 mm) 132 132" (3352 mm) 144 144" (3658 mm) ZZ Other rail length or layout (please specify)	CC Ceiling Cable	48 48" cord (1219mm) 96 96" cord (2438mm) ZZ Other (please specify)
<p style="text-align: center;">See Rail Length Chart for more details.</p> <p style="text-align: center;">⚠ Custom lengths may result in light gaps on the fixture. See Rail Length Chart for more details.</p>					

»			»
---	--	--	---

Power Location	Power Type	Voltage	Emergency Power
Integral Power IP Integral Power Remote Power Specify mounting and harness length code example: 2R25, 2R50 ...etc. Mounting Option 2R Small Round Canopy 4R Large Round Canopy Wire Harness 10 10' (3.048m) Wire Harness 25 25' (7.62m) Wire Harness 50 50' (15.24m) Wire Harness 75 75' (22.86m) Wire Harness 100 100' (30.48m) Wire Harness	Flexible 1 to 1 Power AE 0-10v, 1.0% Dimming AT 0-10v, 0.1% Dimming AD DALI, 0.1% Dimming AX DMX, 100-0% Dimming AH Hi-lume 1% EcoSystem, Soft On / Fade to Black Technology, LDE1 AH2 ELV 1% 2-wire (Forward and Reverse Phase) Optimized Power Add 'O' to power type example: AEO, ATO...etc. ¹ VodeNODE Add 'N' to power type for Flexible 1 to 1 Power Add 'ON' to power type for Optimized Power example: AEN, ATN, AEON, ADON...etc. ² ZZ Other (please specify) See Power Guide for driver features & limitations.	1 120V 2 120V - 277V X Not Yet Specified	0 No Emergency Power ZZ Emergency Power (specify requirements)

»	Z			»
---	----------	--	--	---

LED Type	Lumen Output	90+ CRI	Optics	Sensors ⁴
Z Zipper Board	LO Low Output SO Standard Output HO High Output ZZ Other (please specify) See IES Files page for details. See Power Guide for driver features & limitations.	27 2700K 30 3000K 35 3500K 40 4000K ZZ Tunable White Available See Guide for details	J6 Square 3555, Diffuse ³ J9 Square 3555, Side Diffuse JA Square 3555, Single Side Diffuse	0 None ENC Canopy with integrated Enlighted Micro Sensor WSC Canopy with integrated Legrand Wattstopper sensor LAC Canopy with integrated Lutron Athena sensor ZZ Other (please specify)

»	
---	--

Finish	Options
WH White	0 None
BL Black	9 9' 18/3 Cord and Plug
	CP Chicago Plenum
	LLLL Luminaire Level Lighting Controls

Standard 5 Year Limited Warranty. See details [here](#). Contact factory for options on Limited Warranties up to 20 years.

NOTES & LIMITATIONS

- ¹ Optimized Power is not available with Hi-lume 1% EcoSystem (AHO) Power Type.
 - ² VodeNODE enclosure is not available with ELV 1% 2-wire (AH2) Power Type.
 - ³ Square 3555, Diffuse is only available in White Finish (WH).
 - ⁴ Sensors, drivers and control units that are integrated into Vode fixtures are discrete components that communicate with network lighting controls. For more information about each network lighting control system, visit the manufacturer's website for additional system information and technical data sheets.
- For general information about network lighting controls, consult the DesignLights Consortium® (DLC) [Networked Lighting Control Qualified Product List](#)

Listed to UL standards for damp location by a Nationally Recognized Testing Laboratory (NRTL) recognized by OSHA. Certain limitations exist for each Certification. Contact factory for verification.



Applications

General Interior and Open Office



Square 3555, Critical Edge



Square 3555, Critical Edge



Square 3555, Critical Edge

Declare Label

All Vode Lighting linear light fixtures proudly carry the Red List Approved designation.

See [International Living Future Institute](https://www.living-future.org) website for details.



Vode Adaptive Architectural Lighting Systems
Vode Lighting LLC

Final Assembly: Sonoma, California, US
Life Expectancy: 10+ Year(s)
End of Life Options: Recyclable (100%)

Ingredients:

Anodized Aluminum (6063-T5 Alloy); Steel; Small Electrical Component (RoHS)¹; Copper; **Fluorinated Ethylene Propylene (masterbatch)**²; Polymethyl methacrylate (PMMA); Stainless Steel; Polyoxymethylene Copolymer (POM); Styrene-butadiene polymer, hydrogenated; Poly(methyl methacrylate/butyl acrylate/styrene) (PMMA/BA/S); Styrene/butadiene copolymer; Distillates; Polypropylene; Calcium carbonate; Polycarbonate; EVA Copolymer; Methyl methacrylate (MMA); Polyphenylene Oxide; Brass; Tin, Organic

¹LBC Temp Exception RL-002 - Small Electrical Components
²LBC Temp Exception RL-023 - Wire Sheathing Subject to NFPA 90A, NFPA 262, UL® 910

Living Building Challenge Criteria: Compliant

I-13 Red List:

<input type="checkbox"/> LBC Red List Free	% Disclosed: 100% at 100ppm
<input checked="" type="checkbox"/> LBC Red List Approved	VOC Content: Not Applicable
<input type="checkbox"/> Declared	

I-10 Interior Performance: Not Applicable
I-14 Responsible Sourcing: Not Applicable

VDE-0001
 EXP. 01 JAN 2025
 Original Issue Date: 2018

MANUFACTURER RESPONSIBLE FOR LABEL ACCURACY
 INTERNATIONAL LIVING FUTURE INSTITUTE™ [living-future.org/declare](https://www.living-future.org/declare)



Structure

Rail Lengths	24" (610mm) - 144" (3658mm). Modified lengths available. See Rail Length Chart for more details.
Rail Dimensions	1.38" (35mm) x 2.82" (72mm) x length.
Construction	Extruded and machined 6063 aluminum.
Mounting	Ceiling mount to jbox or driver housing.
Cable Length	48" (1220mm) and 96" (2438mm) available. Field adjustable. Non-standard cable lengths available.
System Run Length	24" (610mm) minimum. Unlimited maximum.
Operating Temperature	32°F to 104°F (0°C to 40°C).
Humidity	0-85%, non-condensing.
System Weight	0.44 lbs per foot (0.20 kg per 305mm) Power supply and housing not included.

Materials

LED Board Construction	Aluminum core PCB, black LCP connectors, RoHS compliant.
Lens	High-impact extruded acrylic glass (PMMA).
Suspension Cable	Ø4mm, 22/4 AWG, TPE jacket, FEP-insulated, Red List Approved.
Power Cable	Ø3mm, 33/2 AWG, Plenum (CMP) rated semi-rigid PVC or FEP, flame tested UL-910, Red List Approved.
Cable Connectors	Unfilled black nylon, rated UL 94 V-0, halogen free, PVC or FEP overmold, RoHS compliant, Red List Approved.
Remote Linear Power Housing	20.7" x 2.375" x 2.53", 0.054" formed Galvanized Steel.
Remote Brick Power Housing	4.32" x 3.37" x .078" Galvanized Steel mounting plate.
Integral Power Housing	extruded and machined 6063 aluminum.
Center Cable Suspension	3/64" aircraft cable.

Mounting Options

Remote Power

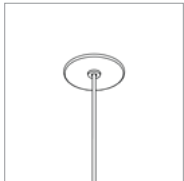

Small Round Canopy
Ø2.5" (51mm)

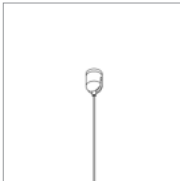

Center Support Cable
108" - 144" Rails Only
Center Support Cable for mounting to T-Bar tile available.

Integral Power (24"-72")

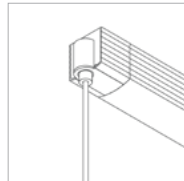

Integral Power (end)
h 1.8" (46mm)
w 1.7" (43mm)

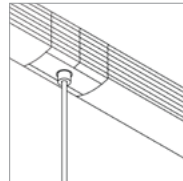

Integral Power (joint)

Dimensions

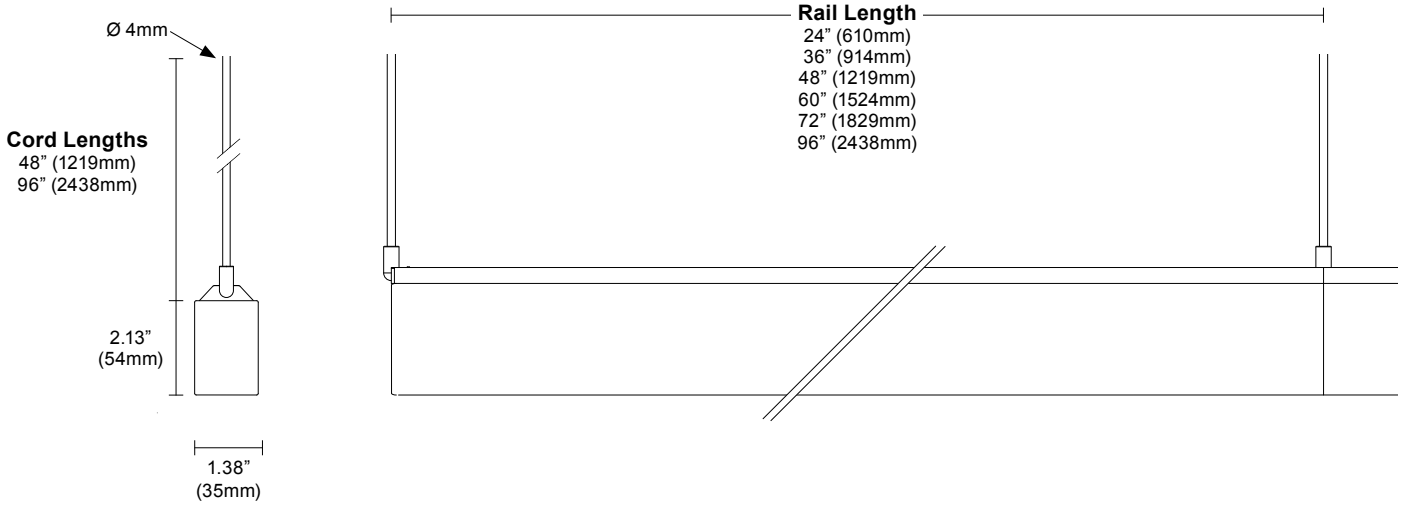

Layout

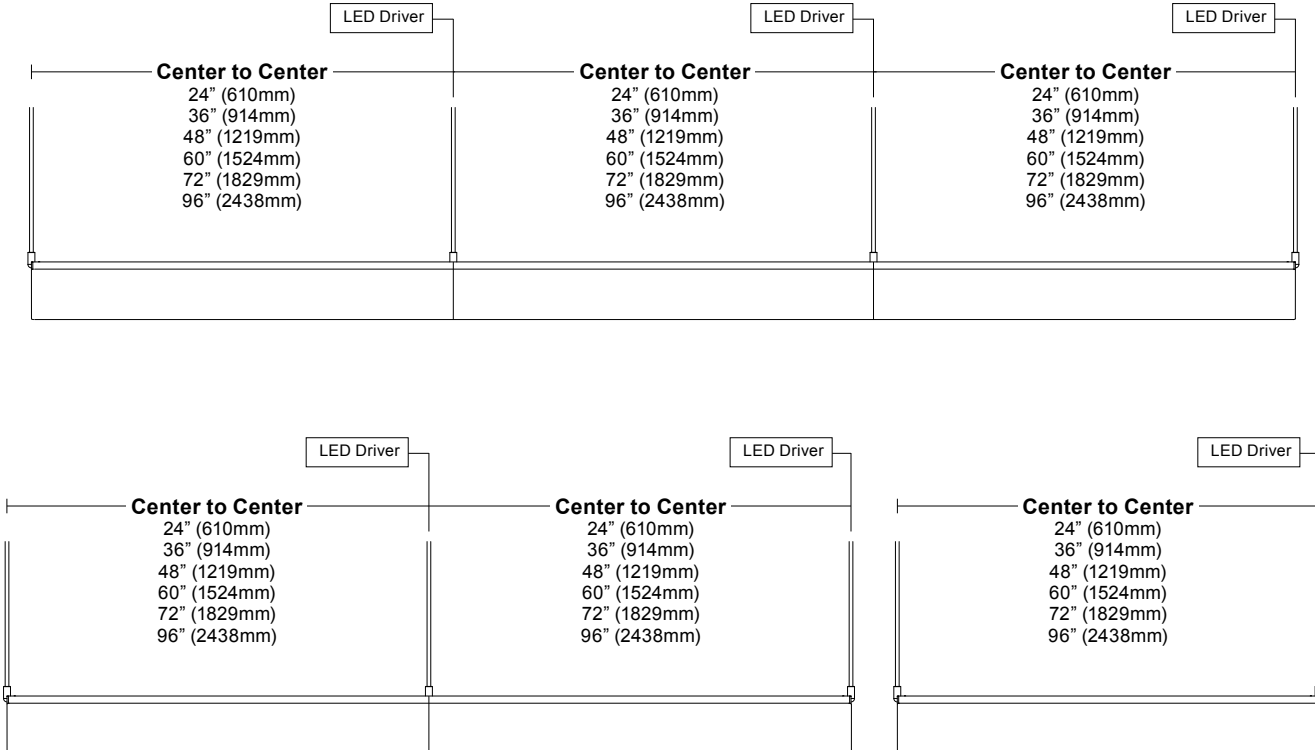

Corner and Shapes Available (Square, Rectangle, L-Shape, U-Shape, ZigZag) [See Guide](#) for details.

Rail Dimensions

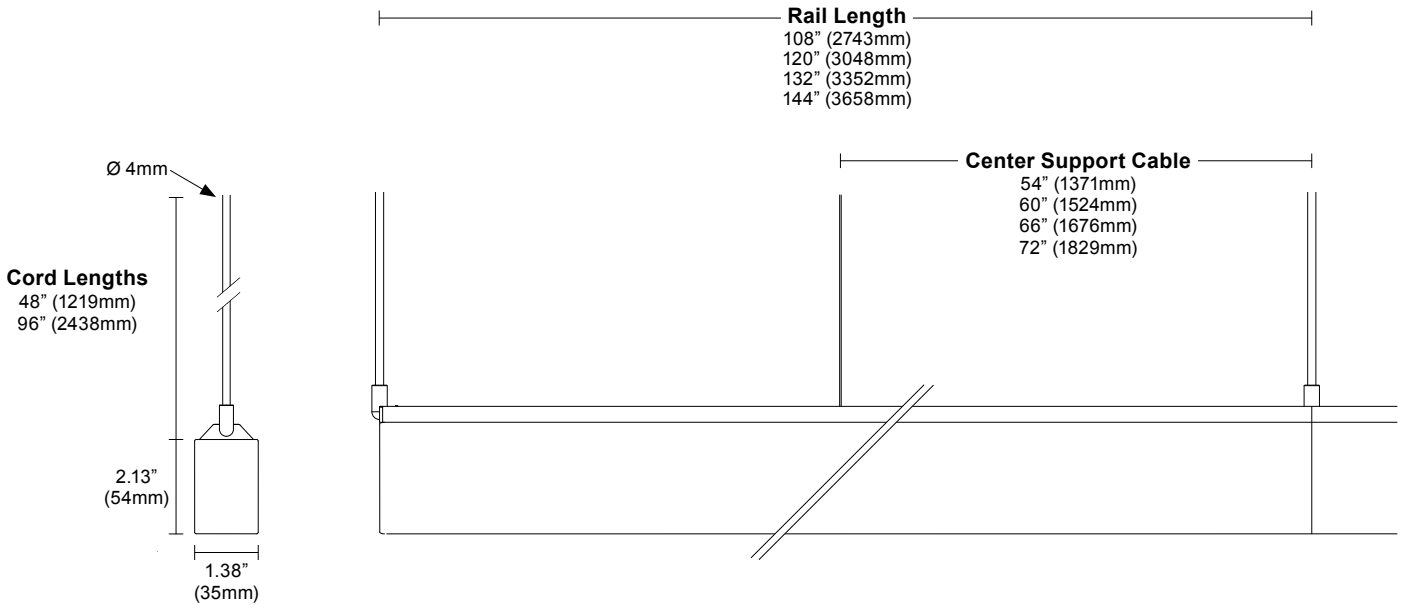

Layout

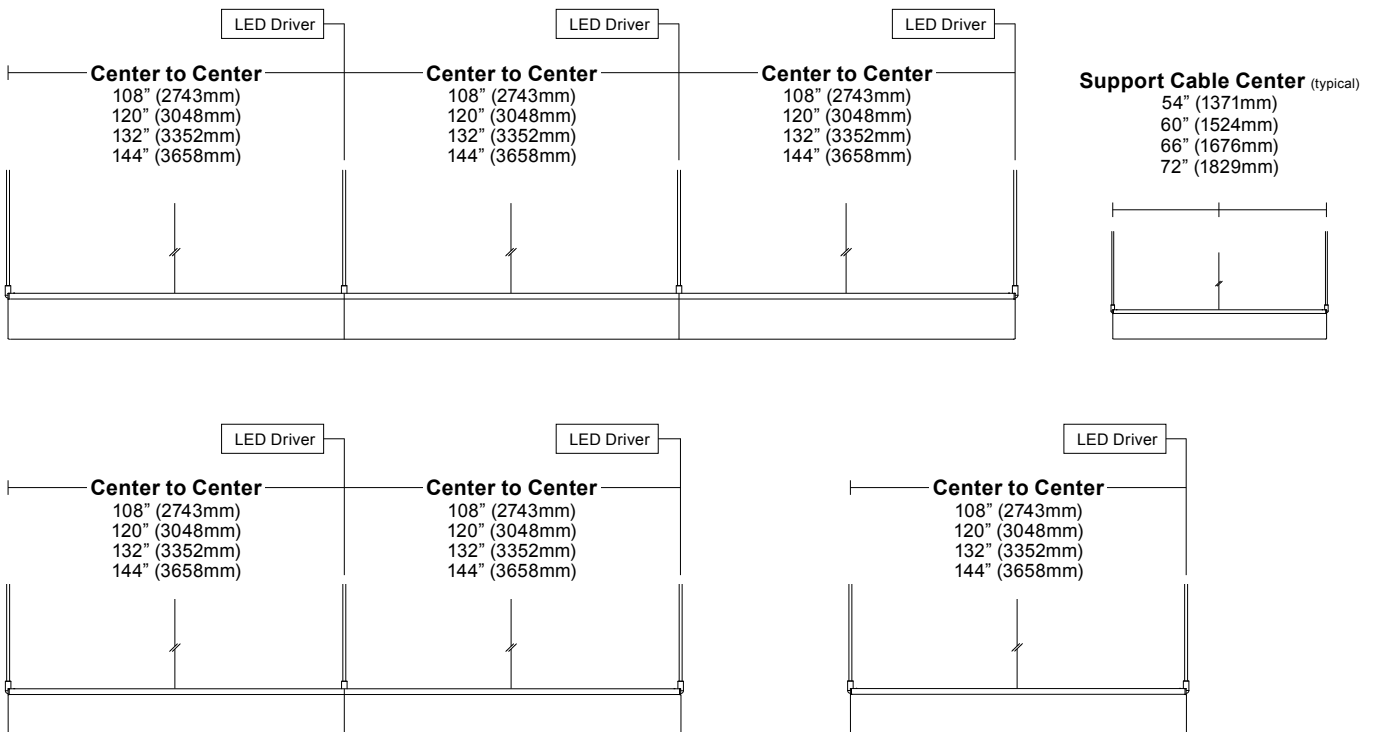

Corner and Shapes Available (Square, Rectangle, L-Shape, U-Shape, ZigZag) [See Guide](#) for details.

vodeCONNECT Sensors

Canopy with integrated sensor

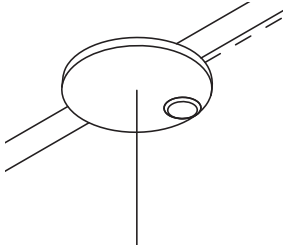

Sensor partners



Integrated canopy sensor layout ¹

1 sensor per fixture. See [vodeCONNECT brochure](#) for more details.

NOTES: 1. Available with Large Round Canopy only.

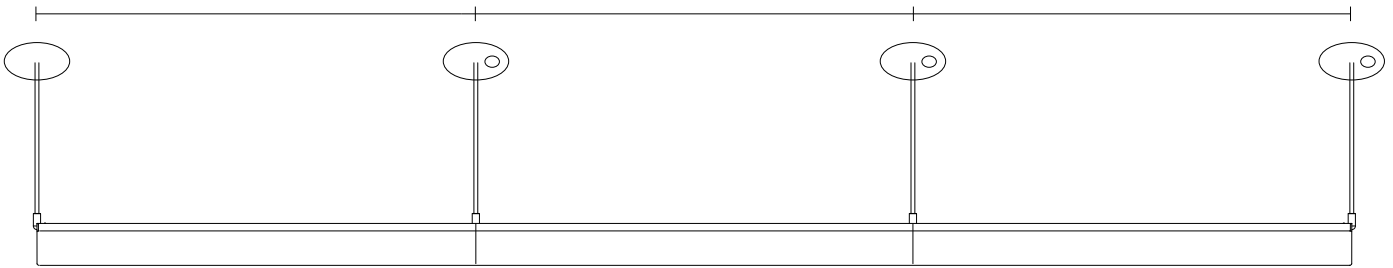

Compatible sensors



Lutron Athena



Legrand Wattstopper



Enlighted Micro Sensor

Power and Controls

Power Type	Class 2 (<60V output) constant current driver.
Dimming Controls	Dimming (0.1%, 1%), 0-10V, DALI, DMX, Hi-lume 1% are available. See Power Guide for details.
Input Voltage	120V - 277V, 50/60hz.
Power Location	Remote power. Maximum remote distance up to 100' (30.5m) depending on driver selection. See Power Guide for details.

Remote power is locating the power supply away from the fixture. Remote power comes in two housing styles: brick style and linear style. Consult [Power Guide](#) to determine which type you will receive.

Remote Brick Power Housing

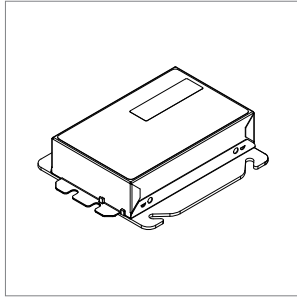

Supplied for some remote power applications. One remote power supply housing is supplied for each rail. Provided driver mounting plate fits standard 4" metal, square J-Boxes with a minimum volume of 21 in³ (J-Box not provided). See [Tech Sheet](#) for details.

Remote Linear Power Housing

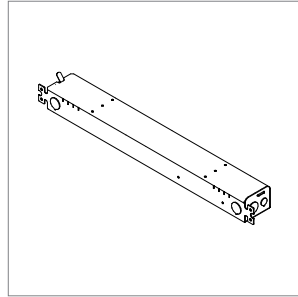

One remote power supply housing is supplied with each power supply. All Vode linear remote drivers come in a 0.054" (0.8mm) formed galvanized steel power supply housing with five (5) knockouts: (4) 1-1/8", (1) 7/8" and (1) 9/16". Accommodates standard linear power supplies. See [Tech Sheet](#) for details.

Integral Power

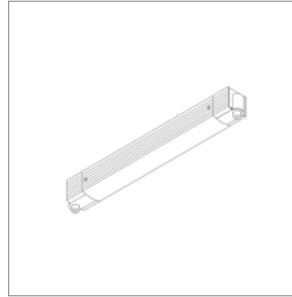

Houses integral power supply. Direct conduit feed is recommended, but integral power supply housing will mount to any standard North America 4" j-box. Mounts to most surfaces. Blocking is recommended at all arm junctions. See [Tech Sheet](#) for details.

Wire Harness

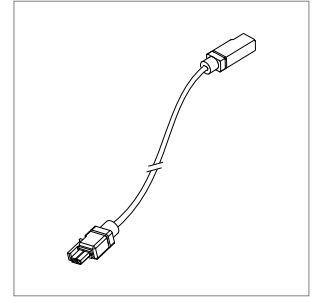

Wire harness connects driver to rail section. Lengths of 10' (3.0m) & 25' (7.6m) with snap-lock connectors for quick and easy installation. Multiple harnesses may be combined for lengths up to 100' (30.5m). See [Tech Sheet](#) for details.

Power and Controls

Flexible 1 to 1 power

For Flexible 1 to 1 Power, Vode supplies one single output driver per fixture, allowing each fixture to be controlled independently. Direct/Indirect fixtures are supplied with two single output drivers, allowing the direct and indirect lighting to be controlled independently. Consult [Power Guide](#) to determine which type you will receive.

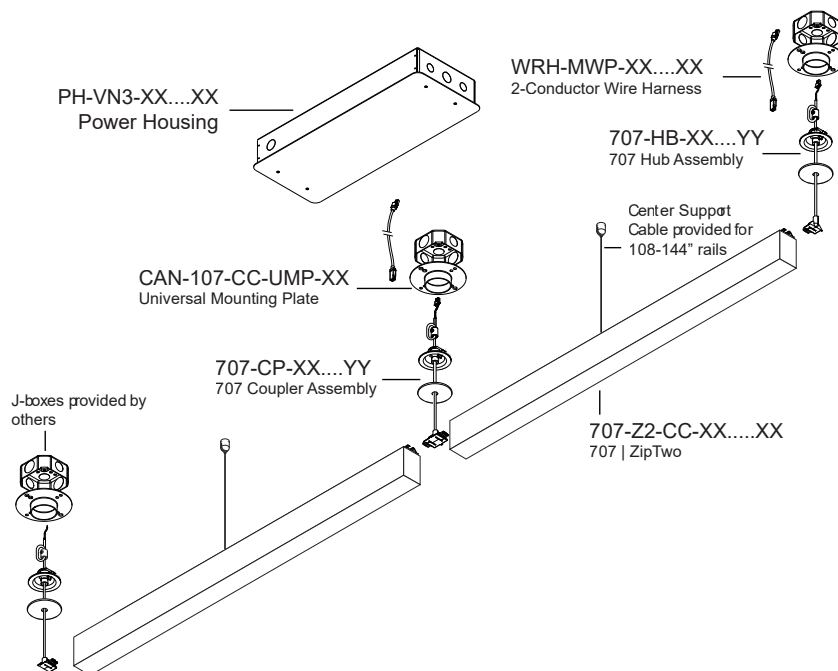

Note: Drawings not to scale, for reference only.

Optimized Power

To optimize power, Vode configures specifications with drivers that have 2 or 4 outputs. Depending on system configurations and power requirements, up to 4 fixtures can be powered from a 4-output driver. Consult [Power Guide](#) to determine which type you will receive.

IMPORTANT: Each fixture will still require individual wire harnesses, as shown below.

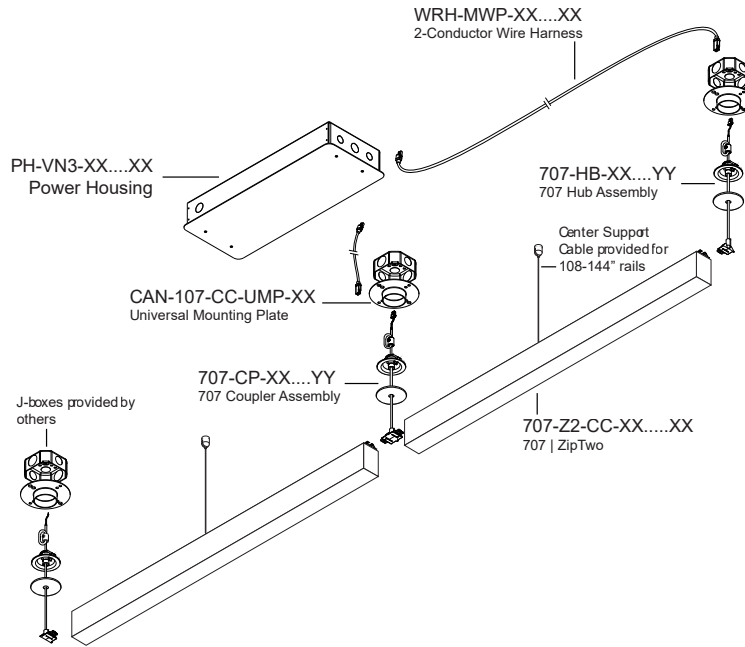

Finish

White Finish



White Rail, White Canopy/Integral Power, White Cable

Black Finish



Black Rail, Black Canopy/Integral Power, Black Cable

Note: Drawings not to scale, for reference only.

Performance | Zipper Board Optics

Zipper Board Optics design has 72 diodes per foot (305mm).

Square 3555, Diffuse, white finish (J6-WH)

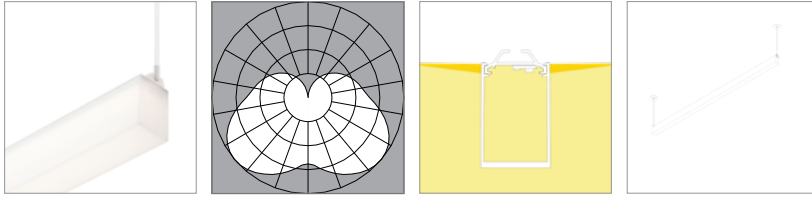

L90 >100,000 hours

	80 CRI (80min., 84 avg.)				90 CRI (90min., 96 avg.)			
	2700K	3000K	3500K	4000K	2700K	3000K	3500K	4000K
Low Output (LO)								
Efficacy - Lumens per Watt	131	135	138	138	113	117	119	120
Lumens per foot (305mm)	487	502	513	513	420	433	442	446
Watts per foot (305mm)	3.8	3.8	3.8	3.8	3.8	3.8	3.8	3.8
Standard Output (SO)								
Efficacy - Lumens per Watt	150	154	158	158	129	133	136	137
Lumens per foot (305mm)	974	1005	1025	1025	840	866	884	893
Watts per foot (305mm)	6.6	6.6	6.6	6.6	6.6	6.6	6.6	6.6
High Output (HO)								
Efficacy - Lumens per Watt	148	153	156	156	128	132	135	136
Lumens per foot (305mm)	1461	1507	1538	1538	1260	1299	1326	1339
Watts per foot (305mm)	9.9	9.9	9.9	9.9	9.9	9.9	9.9	9.9

Square 3555, Side Diffuse, white finish (J9-WH)

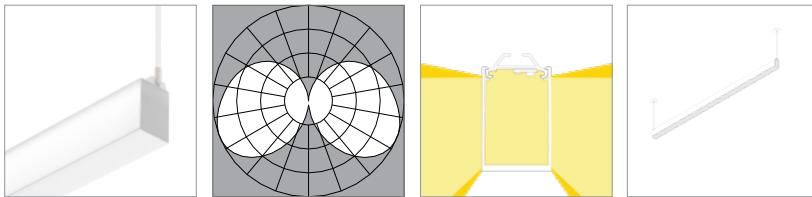

L90 >100,000 hours

	80 CRI (80min., 84 avg.)				90 CRI (90min., 96 avg.)			
	2700K	3000K	3500K	4000K	2700K	3000K	3500K	4000K
Low Output (LO)								
Efficacy - Lumens per Watt	119	123	126	126	103	106	108	110
Lumens per foot (305mm)	443	457	466	466	382	394	402	406
Watts per foot (305mm)	3.8	3.8	3.8	3.8	3.8	3.8	3.8	3.8
Standard Output (SO)								
Efficacy - Lumens per Watt	136	140	143	143	117	121	123	125
Lumens per foot (305mm)	885	913	932	932	763	787	804	812
Watts per foot (305mm)	6.6	6.6	6.6	6.6	6.6	6.6	6.6	6.6
High Output (HO)								
Efficacy - Lumens per Watt	135	139	142	142	116	120	122	124
Lumens per foot (305mm)	1328	1370	1398	1398	1145	1181	1205	1217
Watts per foot (305mm)	9.9	9.9	9.9	9.9	9.9	9.9	9.9	9.9

Performance | Zipper Board Optics

Zipper Board Optics design has 72 diodes per foot (305mm).

Square 3555, Single Side Diffuse, white finish (JA-WH)

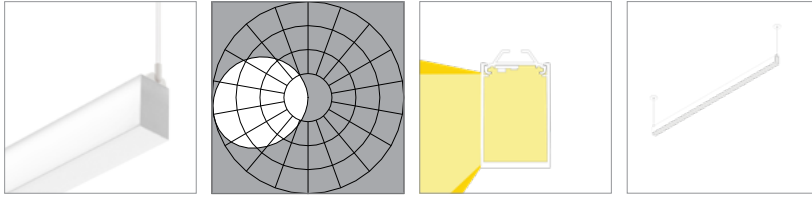

L90 >100,000 hours

	80 CRI (80min., 84 avg.)				90 CRI (90min., 96 avg.)			
	2700K	3000K	3500K	4000K	2700K	3000K	3500K	4000K
Low Output (LO)								
Efficacy - Lumens per Watt	96	99	101	101	83	86	87	88
Lumens per foot (305mm)	356	367	375	375	307	316	323	326
Watts per foot (305mm)	3.8	3.8	3.8	3.8	3.8	3.8	3.8	3.8

Standard Output (SO)								
Efficacy - Lumens per Watt	110	113	115	115	94	97	99	100
Lumens per foot (305mm)	712	734	749	749	613	633	646	652
Watts per foot (305mm)	6.6	6.6	6.6	6.6	6.6	6.6	6.6	6.6

High Output (HO)								
Efficacy - Lumens per Watt	108	112	114	114	94	97	98	99
Lumens per foot (305mm)	1067	1101	1124	1124	920	949	969	978
Watts per foot (305mm)	9.9	9.9	9.9	9.9	9.9	9.9	9.9	9.9

Square 3555, Side Diffuse, black finish (J9-BL)

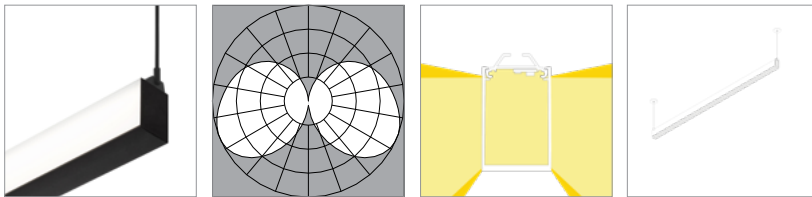

L90 >100,000 hours

	80 CRI (80min., 84 avg.)				90 CRI (90min., 96 avg.)			
	2700K	3000K	3500K	4000K	2700K	3000K	3500K	4000K
Low Output (LO)								
Efficacy - Lumens per Watt	100	103	105	105	86	89	91	91
Lumens per foot (305mm)	369	381	389	389	318	328	335	338
Watts per foot (305mm)	3.8	3.8	3.8	3.8	3.8	3.8	3.8	3.8

Standard Output (SO)								
Efficacy - Lumens per Watt	114	117	120	120	98	101	103	104
Lumens per foot (305mm)	739	762	777	777	637	657	670	677
Watts per foot (305mm)	6.6	6.6	6.6	6.6	6.6	6.6	6.6	6.6

High Output (HO)								
Efficacy - Lumens per Watt	113	116	118	118	97	100	102	103
Lumens per foot (305mm)	1108	1143	1166	1166	955	985	1005	1015
Watts per foot (305mm)	9.9	9.9	9.9	9.9	9.9	9.9	9.9	9.9

Performance | Zipper Board Optics

Zipper Board Optics design has 72 diodes per foot (305mm).

Square 3555, Single Side Diffuse, black finish (JA-BL)

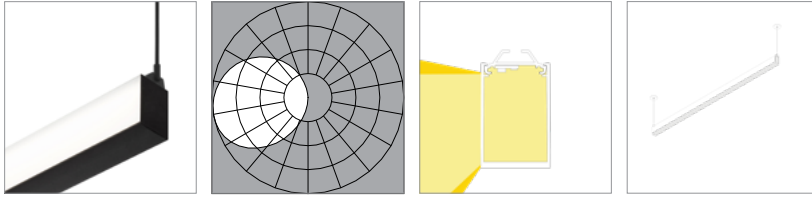

L90 >100,000 hours

	80 CRI (80min., 84 avg.)				90 CRI (90min., 96 avg.)			
	2700K	3000K	3500K	4000K	2700K	3000K	3500K	4000K
Low Output (LO)								
Efficacy - Lumens per Watt	75	78	79	79	65	67	68	69
Lumens per foot (305mm)	278	287	293	293	240	248	253	255
Watts per foot (305mm)	3.8	3.8	3.8	3.8	3.8	3.8	3.8	3.8
Standard Output (SO)								
Efficacy - Lumens per Watt	86	88	90	90	74	76	78	78
Lumens per foot (305mm)	557	574	586	586	480	495	505	510
Watts per foot (305mm)	6.6	6.6	6.6	6.6	6.6	6.6	6.6	6.6
High Output (HO)								
Efficacy - Lumens per Watt	85	88	89	89	73	76	77	78
Lumens per foot (305mm)	835	862	879	879	720	743	758	765
Watts per foot (305mm)	9.9	9.9	9.9	9.9	9.9	9.9	9.9	9.9

Copyright © 2025 Vode Lighting LLC. All rights reserved. Vode, the Vode logo, BoxRail, FlyWing, MicroBaffle, Button Board, Zipper Board, Zero Canopy, Zero Block, VodeNODE and other names are either registered trademarks or trademarks of Vode Lighting LLC in the United States and may be registered in other countries. All other trademarks listed herein belong to their respective owners. Due to ongoing innovation, specification details may change without notice.