



DISCONTINUED
Call your local Vode rep or
Vode Sales Support to order.
(707) 996-9898

Spec Guide

WingRail™ | Table Arm | T5 | 105

Task lighting for corporate, educational and library applications.



WingRail, direct or indirect, 370° rotation.

Benefits & Features

Low Profile Robust Design

Asymmetric profile, 1.12" (28mm) x 2.12" (54mm), 370° rotation, angle gage and lock.

Superior Light Quality & Performance

For HE & HO lamps. 49% fixture efficacy. Extruded aluminum reflector with optional baffle or prismatic lens.

Adaptive Power Modules

1% dimming available for most configurations and protocols.

Elegant Power Accessories

In-table power receptacle and on/off switch options available.



Shown: Arm Anchor

Multiple mounting hardware options designed to fit any application.

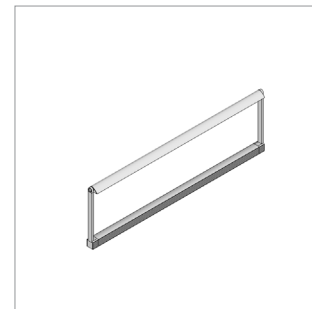

Shown: Integral Ballast

Structure

Rail Lengths	24" (610mm), 36" (914mm), 48" (1219mm), 60" (1524mm).
Rail Dimensions	1.12" (28mm) x 2.12" (54mm).
Construction / Finish	Extruded and machined 6063 aluminum. Clear anodized (stock), black anodized, white painted and non-standard finishes available.
Mounting	Table mount to Arm Anchor or integral ballast housing. <i>See following page for details.</i>
Arm Length	1.25' (32mm) – 48" (1219mm). Non-standard arm lengths available. Arm lengths >48" (1219mm) not recommended.
System Run Length	2' (610mm) minimum. Unlimited maximum.

Power / Controls

Ballast Type	Thermally protected Class P and Sound Rated A.
Controls	Non-dimming and dimming (1%, 10%). 0-10V, DALI, Lutron™ available for most configurations. <i>See Ballast Guide for details.</i>
Input Voltage	120v, 240v, 277v.
Power Location	Integral or remote power. Maximum ballast distance from fixture up to 18' (5m) depending on ballast type. <i>See Ballast Guide for details.</i>
Emergency Ballast	Available with select ballasts. <i>See Ballast Guide for details.</i>

Light

Fixture Efficacy (lm/W)	49% efficacy.
Distribution	Asymmetric distribution, 83% direct, 17% indirect.
T5 Lamp HE (High Efficiency)	14W = 24" (600mm) lamp. 21W = 36" (900mm) lamp. 28W = 48" (1200mm) lamp. 35W = 60" (1500mm) lamp.
T5 Lamp HO (High Output)	24W = 24" (600mm) lamp. 39W = 36" (900mm) lamp. 54W = 48" (1200mm) lamp. 80W = 60" (1500mm) lamp.
Color Temperature	3000K, 3500K, 4100K. Other color temperature lamps available on request.

DISCONTINUED
To order, call
(707) 996-9898

Mounting Hardware

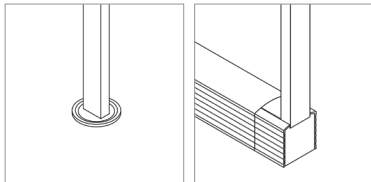

Arm Anchor
h 0.1" (3mm)
Ø2" (51mm)

Integral Power
h 1.7" (43mm)
w 1.8" (46mm)

Accessories

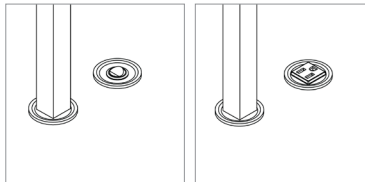

On/Off Switch

Receptacle

Dimensions

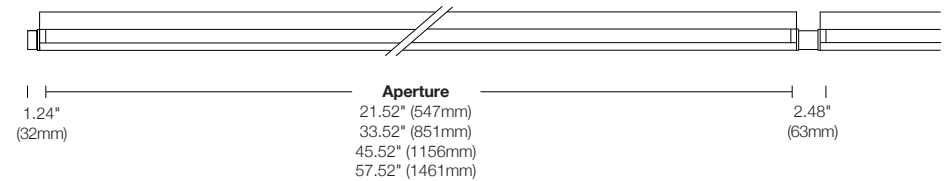
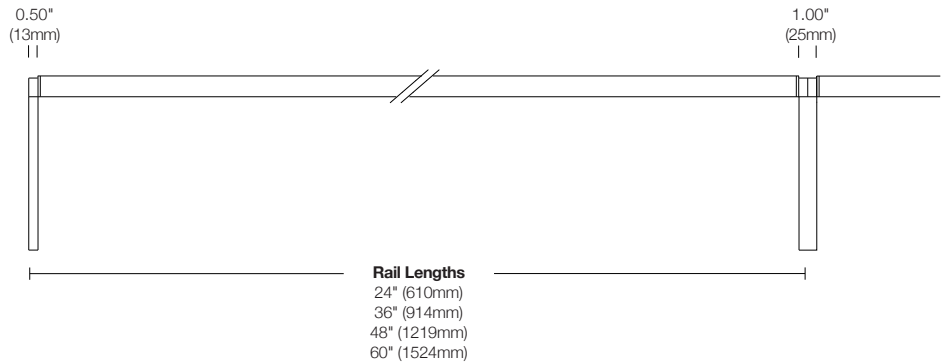
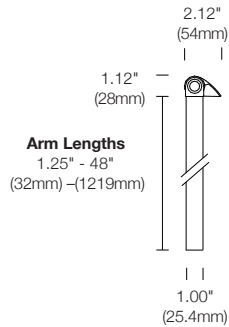

Materials

Prismatic Lens	High-impact extruded acrylic glass (PMMA).
Baffle	6063 aluminum, painted white finish, RoHS compliant.
Power Cable	Ø6mm, 18/4 AWG, fiberglass sheathing, FEP insulation, RoHS compliant.
Cable Connectors	Unfilled clear Nylon, rated UL 94 V-0, halogen free. RoHS compliant.
Remote Power Housing	1/16" (0.8mm) formed steel, zinc chromate plating.

5 Year Limited Warranty. All material and component parts used in the manufacture of Vode products are warranted to be free from defects of material and/or workmanship for a period of 5 years from date of sale. Product must be installed according to Vode installation instructions and accepted trade practices. Ballasts and other auxiliary equipment is not covered under Vode warranty but may be covered by separate OEM warranty. See full Vode warranty description [here](#).

Listed to UL standards for dry and damp location by a Recognized Testing Laboratory (NRTL) recognized

DISCONTINUED
To order, call
(707) 996-9898

Build Your Specification

105-WG				TA		
--------	--	--	--	----	--	--

System & Rail Type	Single/Double Rail	System Length	Layout	Mounting	Arm Length	Ballast Location
105-WG WingRail	01 Single Rail 03 Double Rail w/3" (76mm) tee 06 Double Rail w/6" (76mm) tee 12 Double Rail w/12" (76mm) tee 18 Double Rail w/18" (76mm) tee 24 Double Rail w/24" (76mm) tee Z Double Rail w/non-standard tee (please specify)	Specify system length in 1ft (305mm) increments.	Select a standard layout using the Layout Chart on page 6. Find your desired overall system length and choose Layout A, B or C. This product is available with rail lengths from 2' (610mm) – 5' (1524mm). To select a non-standard layout, write "Z" above and specify your layout in comma delimited feet/inches or millimeters. Example: 3',3',3',3' for a 12ft system.	TA Table Arm	1.25 1.25" arm (32mm) 1.75 1.75" arm (44mm) 3 3" arm (76mm) 6 6" arm (152mm) 12 12" arm (305mm) 18 18" arm (457mm) 24 24" arm (610mm) 36 36" arm (914mm) 48 48" arm (1219mm) Z Non-standard arm length (please specify) ¹	Integral Ballast IB Integral Ballast ² Remote Ballast 2T Arm Anchor

--	--	--	--	--	--	--

Ballast Type ³	Voltage	Emergency Ballast	Lamp Type	Finish	Lens / Baffle
I Instant Start, Non-dimming A Programmed Start, Non-dimming E Lutron Ecosystem, 10% Dimming H Lutron Hi-Lume 3D, 1% Dimming J Lutron Ecosystem H-Series, 1% Dimming F 0-10v, 1% Dimming D DALI, 1% Dimming Z Other (please specify)	1 120v 4 240v 2 277v	Specify number of emergency ballasts required. See Ballast Guide for details.	Supplied by Others HE High Efficiency HO High Output Supplied by Vode E30 Sylvania Pentron, 3000K, HE E35 Sylvania Pentron, 3500K, HE E41 Sylvania Pentron, 4100K, HE O30 Sylvania Pentron, 3000K, HO O35 Sylvania Pentron, 3500K, HO O41 Sylvania Pentron, 4100K, HO Z Other (please specify)	AL Clear Anodized (stock) WH White Painted BL Black Anodized Z Non-standard Finish (please specify)	0 None B Cross Baffle 1 Prismatic Lens ⁴

--	--

Sensors	Options
0 None Z Other (please specify) ⁵	Select all that apply. 0 None 1 On/off Switch ⁶ 2 GLR Fuse 3 9' 18/3 Cord and Plug 4 Conduit adapter for end power feed ⁷

NOTES & LIMITATIONS

- ¹Arm lengths >48" (1219mm) not recommended.
- ²Not recommended for arm lengths >12" (305mm).
- ³Some ballasts may not be compatible with your specification. See [Ballast Guide](#) for details.
- ⁴Not available with High Output (HO) Lamps.
- ⁵Occupancy and daylight sensors are available. Contact Vode or your Vode agent with your specific requirements.
- ⁶One switch per ballast, unless otherwise specified.
- ⁷Requires Integral Ballast (IB).

Layout

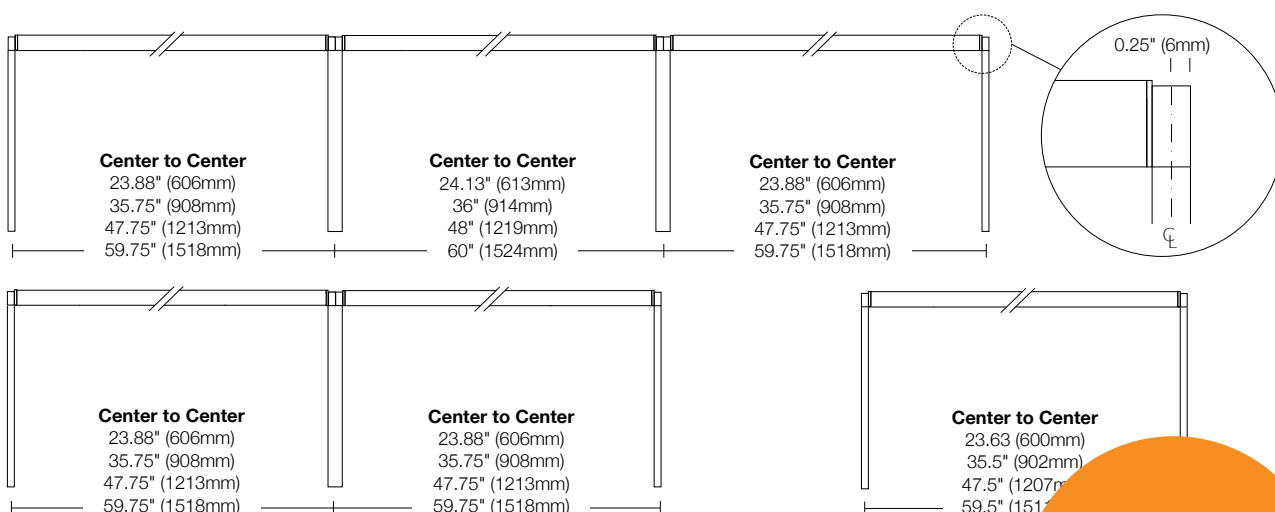

DISCONTINUED
 To order, call
(707) 996-9898